

# NOTICE

**Note that when converting this document from its original format to a .pdf file, some minor font and format changes may occur. When viewing and printing this document, we cannot guarantee that your specific PC or printer will support all of the fonts or graphics. Therefore, when you view the document, fonts may be substituted and your individual printer may not have the capability to print the document correctly.**



# NEC

## *D<sup>term</sup>*<sup>®</sup> Cordless DECT

---

OWNER'S MANUAL

DTL-8R-1

INT-2070 (DECT)  
DOCUMENT REVISION 2



Contents of this manual are subject to change without prior notice at the discretion of **NEC Unified Solutions, Inc.** This document has been prepared for the use of employees and customers of **NEC Unified Solutions, Inc.** and may not be reproduced without prior written approval of **NEC Unified Solutions, Inc.**

*D<sup>term</sup>* is a registered trademark of NEC Corporation.

Copyright 2009

**NEC Infrontia, Inc.**  
**6535 N. State Highway 161**  
**Irving, TX 75039-2402**

Technology Development



# TABLE OF CONTENTS

---

---

## *Chapter 1 Specifications and Safety Information*

<b>Section 1</b>	<b>Specifications .....</b>	<b>1-1</b>
<b>Section 2</b>	<b>Battery Safety .....</b>	<b>1-2</b>
<b>Section 3</b>	<b>Important Safety Instructions.....</b>	<b>1-3</b>
<b>Section 4</b>	<b>Important Electrical Considerations.....</b>	<b>1-4</b>

## *Chapter 2 About the D<sup>term</sup> Cordless DECT*

<b>Section 1</b>	<b>Overview.....</b>	<b>2-1</b>
<b>Section 2</b>	<b>Items Included with the D<sup>term</sup> Cordless DECT .....</b>	<b>2-2</b>
<b>Section 3</b>	<b>Features of the Cordless Telephone .....</b>	<b>2-3</b>
<b>Section 4</b>	<b>D<sup>term</sup> Controls and Functions.....</b>	<b>2-4</b>
	4.1 Handset .....	2-4
	4.2 Base Unit .....	2-6
	4.3 Cordless Handset/Desk Phone Switch (Base Key Option) .....	2-6
	4.4 Charger Unit .....	2-7

## *Chapter 3 Installation*

<b>Section 1</b>	<b>Selecting a Location.....</b>	<b>3-1</b>
<b>Section 2</b>	<b>Installation Precautions .....</b>	<b>3-1</b>
<b>Section 3</b>	<b>Connecting the Telephone Cords .....</b>	<b>3-1</b>
<b>Section 4</b>	<b>Applying Power to the Charging Unit.....</b>	<b>3-3</b>

<b>Section 5</b>	<b>Wall Installation .....</b>	<b>3-4</b>
5.1	Mounting the Base to a Standard Wall Plate .....	3-4
5.2	Mounting the Base Directly to the Wall .....	3-6
5.3	Wall Mounting the Charging Unit .....	3-8
<b>Section 6</b>	<b>Attaching and Removing the Belt Clip .....</b>	<b>3-11</b>
<b>Section 7</b>	<b>Installing the Handset Battery Pack.....</b>	<b>3-12</b>
<b>Section 8</b>	<b>Charging Batteries.....</b>	<b>3-13</b>
8.1	Charging the Handset Battery Pack .....	3-13
8.2	Charging Spare Battery Packs .....	3-14
<b>Section 9</b>	<b>Low Battery Indicator.....</b>	<b>3-15</b>
9.1	Low Battery .....	3-15
9.1.1	In Standby Mode .....	3-15
9.1.2	In Talk Mode .....	3-15
9.1.3	In Other Mode (Excluding Standby Mode and Talk Mode) .....	3-15
9.2	Battery Status .....	3-15
<b>Section 10</b>	<b>Cleaning the Battery Charger Contacts.....</b>	<b>3-16</b>

## ***Chapter 4 D<sup>term</sup> Handset, Base Unit and Charging Unit***

<b>Section 1</b>	<b>Handset Controls.....</b>	<b>4-1</b>
<b>Section 2</b>	<b>Base Unit Controls .....</b>	<b>4-3</b>
<b>Section 3</b>	<b>Charger Unit.....</b>	<b>4-5</b>

## ***Chapter 5 Optional Equipment Installation***

<b>Section 1</b>	<b>Optional Accessories and Replacement Parts .....</b>	<b>5-1</b>
<b>Section 2</b>	<b>Installing the Optional Headset.....</b>	<b>5-2</b>



<b>Section 3</b>	<b>Installing the Optional DTL-8R Handset Kit .....</b>	<b>5-3</b>
3.1	Limitations .....	5-3
3.2	Conference .....	5-3
3.3	Transfer a Call to the Other Handset .....	5-4
3.4	Registering a Second Handset to the Base Unit .....	5-4
3.4.1	View and Record the Base Registration PIN .....	5-4
3.4.2	Registration of the Second Handset .....	5-5

## *Chapter 6 Setup and Operation*

<b>Section 1</b>	<b>Setting Up and Programming the DTL-8R-1 .....</b>	<b>6-1</b>
1.1	Programming Mode .....	6-1
1.1.1	Training Mode (Entry) .....	6-1
1.1.2	Training Mode (Volume Down key: Select Item) .....	6-1
1.1.3	Training Mode (Volume Up Key – Change Each Item Setting) ..	6-3
1.1.4	Training Mode (0 Key – No Function) .....	6-5
1.1.5	Training Mode (TALK Key or Speaker Key – Exit from the Training Mode) .....	6-5
<b>Section 2</b>	<b>NEC PBX Operation.....</b>	<b>6-5</b>
2.1	Switching Between the Wired Phone and Cordless Phone (DTL-8R-1 Handset) .....	6-6
2.2	Making a Call to Another Extension .....	6-7
2.3	Making Call to Outside Line .....	6-8
2.4	Receiving a Call from an Outside Line (Depends on PBX Line) .....	6-9
2.5	Redial (Option) .....	6-10
2.6	AutoStandby® .....	6-10
2.7	PBX No Service .....	6-11
2.8	Out Of Range .....	6-11

2.8.1	When in Standby Mode .....	6-11
2.8.2	When Establishing an RF Link .....	6-11
2.8.3	While Talking .....	6-12
2.9	Low Battery .....	6-12
2.9.1	In Standby Mode .....	6-12
2.9.2	In Talk Mode .....	6-12
2.9.3	In Other Mode (Excluding Standby Mode and Talk Mode) .....	6-12
2.10	Battery Status .....	6-12
2.11	Handsfree .....	6-13
2.12	Headset .....	6-13
2.13	Volume Setting .....	6-13
2.14	Ring Volume Setting .....	6-13
2.14.1	Ringer Tone/Volume Selection .....	6-13
2.15	Ringer Mute .....	6-14
2.16	Menu Setting Mode .....	6-15
2.17	Changing Ringer Type .....	6-15
2.18	End of Range Alarm .....	6-16

# LIST OF FIGURES AND TABLES

---

---

Figure 2-1	System Overview .....	2-1
Figure 2-2	Items Included with the <i>D<sup>term</sup></i> Cordless DECT .....	2-2
Figure 2-3	Handset Controls and Functions .....	2-5
Figure 2-4	Base Unit Controls and Functions .....	2-6
Figure 2-5	Charging Unit Controls and Functions .....	2-7
Figure 3-1	Connecting Telephone Cords to the Telephone Jack .....	3-2
Figure 3-2	Connecting the <i>D<sup>term</sup></i> Cordless DECT to the Multiline Terminal .....	3-2
Figure 3-3	Applying Power to the Charging Unit .....	3-3
Figure 3-4	Polarized Plug .....	3-4
Figure 3-5	Attaching the Wall Mount Stand to the Base Unit .....	3-4
Figure 3-6	Placing the AC Adapter Cord Inside the Wall Mount Stand .....	3-5
Figure 3-7	Placing the Base Unit on the Posts of the Wall Plate .....	3-5
Figure 3-8	Plugging the AC Adapter into the AC Wall Outlet .....	3-6
Figure 3-9	Inserting Screws into the Wall for Wall Mounting the Telephone .....	3-7
Figure 3-10	Placing the Telephone Cords Inside the Wall Mount Stand .....	3-7
Figure 3-11	Attaching the Wall Mount Unit to the Wall .....	3-8
Figure 3-12	Inserting Screws for Wall Mounting .....	3-9
Figure 3-13	Wrapping the AC Adapter Cord Around the Strain Relief .....	3-9
Figure 3-14	Placing the Charging Unit on the Wall .....	3-10
Figure 3-15	Attaching the Belt Clip to the Handset .....	3-11
Figure 3-16	Removing the Belt Clip .....	3-11
Figure 3-17	Removing the Battery Cover .....	3-12
Figure 3-18	Replacing the Battery Pack .....	3-13
Figure 3-19	Replacing the Battery Cover .....	3-13

Figure 3-20	Charging the Battery Pack .....	3-14
Figure 3-21	Cleaning Battery Charger Contacts .....	3-16
Figure 4-1	Handset Controls .....	4-1
Table 4-1	Handset Control Functions .....	4-2
Figure 4-2	Base Unit Controls and Functions .....	4-4
Figure 4-3	Charging Unit Controls and Functions .....	4-5
Figure 5-1	Optional Accessories and Replacement Parts .....	5-1
Figure 5-2	Installing the Headset .....	5-2
Figure 5-3	Optional DTL-8R Handset .....	5-3

# CHAPTER 1 *Specifications and Safety Information*

---

## SECTION 1 SPECIFICATIONS

The D<sup>term</sup> Cordless DECT complies with FCC and IC part 15.

### General

RoHs	Yes
Frequency	1.9G (1920 ~ 1930 MHz) DECT 6.0
Audio Process	Digital (ADPCM)
Operating Temperature	0° ~ +50° C (+32° F to +122° F)
Transmission	TDMA/TDD
Channels	5
ID #	130,000 combinations
WiFi Friendly	Yes

### Base Unit

Receive/Transmit Frequency	1920 ~ 1930 MHz
Power Requirements	10 Vdc from supplied AC adapter
Size	58mm (H) x 215mm (D) x 130mm (W)
Weight	410g

### Handset

Receive/Transmit Frequency	1920 ~ 1930 MHz
Power Requirements	Nickel-Metal Hydride battery pack
Size	163mm (H) x 31mm (D) x 55mm (W)
Weight	150g (Handset = 120g + Battery pack = 30g)
Battery	Capacity 910 mAh, 2.4V
Talk Mode	16 hours (typical)
Standby Mode	7 days (typical)

## Battery Charger

Power Requirements	9V DC from supplied AC adapter
Size	75mm (H) x 100mm (D) x 87mm (W)

## SECTION 2

### BATTERY SAFETY



*To reduce the risk of fire or injury to persons by the battery, read and follow these instructions.*

- This equipment contains a rechargeable nickel-metal hydride battery.
- Do not** short-circuit the battery.
- Do not** charge the rechargeable nickel-metal hydride battery used in this equipment in any charger other than the one designed to charge this battery as specified in this manual. Using another charger can damage the battery or cause the battery to explode.
- Use only the appropriate type and size battery pack specified in this manual.
- Do not** open or mutilate the battery pack. Released electrolyte is corrosive and can cause damage to the eyes or skin. It may be toxic if swallowed.
- Exercise care in handling the battery in order not to short the battery with conducting materials such as rings, bracelets, and buttons. The battery or conductor can overheat and cause burns.
- Charge the battery pack provided with or identified for use with this product only in accordance with the instructions and limitations specified in the instruction manual provided for this product.
- Observe proper polarity orientation between the battery pack and battery charger.
- Do not** dispose of the battery pack in a fire, the cell may explode.
- Do not** place the batteries in your regular trash. The nickel-metal hydride battery must be collected, recycled, or disposed of in an environmentally sound manner. Contact your local waste management officials for other information regarding the environmentally sound collection, recycling and disposal of the battery contained in this product.

### SECTION 3      IMPORTANT SAFETY INSTRUCTIONS

When using the telephone equipment, basic safety precautions should always be followed to reduce the risk of fire, electrical shock, and injury to persons, including the following:

- Read and understand all instructions.
- Follow all warnings and instructions marked on the product.
- Unplug this product from the wall outlet before cleaning. **Do not** use liquid cleaners or aerosol cleaners. Use a dry cloth for cleaning.
- Do not** use this product near water; for example, near a sink or in a wet area.
- Do not** place this product on an unstable cart, stand, or table. The telephone can fall, causing serious damage to the unit.
- To protect the product from overheating, do not block or cover any slots or openings in the base unit. This product should never be placed near or over a radiator or heat register. This product should not be placed in a built-in installation unless the proper ventilation is provided.
- This product should be operated only from the type of power source indicated on the marking label.
- Do not** allow anything to rest on the power cord. Do not locate this product where the cord will be damaged by people walking on it.
- Do not** overload wall outlets and extension cords, as this can result in the risk of fire or electrical shock.
- Never push objects of any kind into this product through the base unit slots, as they may touch dangerous voltage points or short out parts that could result in a risk of fire or electrical shock. Never spill liquid of any kind on the product.
- To reduce the risk of electric shock, do not disassemble this product. Contact qualified service personnel when some service or repair work is required. Opening or removing covers may expose you to dangerous voltages or other risks. Incorrect reassembly can cause electric shock when the appliance is subsequently used.
- Unplug this product from the wall outlet and refer servicing to qualified service personnel under the following conditions:
  - When the power supply cord is damaged or frayed.
  - If liquid has been spilled onto the product.
  - If the product has been exposed to water or rain.
  - If the product does not operate normally when following the operating instructions. Adjust only those controls that are covered by the operating instructions. Improper adjustment of other controls can result in damage, and will often require extensive work by a qualified technician to restore the product to normal operation.
  - If the product has been dropped, or the cabinet has been damaged.

- ❑ If the product exhibits a distinct change in performance.
- ❑ **Do not** use the telephone to report a gas leak in the vicinity or the leak.
- ❑ To reduce the risk of fire or injury to persons by the battery, read and follow these instructions.
  - Use only the appropriate type and size battery pack specified in the manual.
  - Exercise care in handling the battery in order not to short the battery with conducting materials such as rings, bracelets, and buttons. The battery or conductor can overheat and cause burns.

### Privacy

Cordless telephones are radio devices. Communications between the handset and base of the cordless telephone are accomplished by means of radio waves which are broadcast over the open airways. Because of the inherent physical properties of radio waves, communication can be received by radio receiving devices other than your own telephone unit, consequently, any communications using the cordless telephone may not be private.

## SECTION 4 IMPORTANT ELECTRICAL CONSIDERATIONS



***Do not attempt to unplug any appliance during an electrical storm.***

Unplug all electrical appliances when you know an electrical storm is approaching. Lightning can pass through your household wiring and damage any device connected to it. This telephone is no exception.

### Caution:



***Changes or modifications to this product not expressly approved by NEC Unified Solutions, Inc., or operation of this product in any way other than as detailed by this manual, could void your authority to operate this product.***



## Range

Nominal values of the DECT system are:

- 164 feet (50 meters) – Indoor
- 984 feet (300 meters) – Outdoor

The telephone is designed to achieve a maximum range of up to 350 feet (depending upon the environment), by transmitting and receiving according to the highest specifications set forth by the FCC. We have rated this phone to operate at a maximum distance with the qualification that the range depends upon the environment in which the telephone is used. Many factors limit range, and it would be impossible to include all of the variables in our rating. The maximum range rating of this telephone is meant to be used as a means of comparison against other range claims.

## Telephone Line Problems

The FCC has granted the telephone company the right to disconnect service in the event that your telephone causes problems on the telephone line. Also, the telephone company may make changes in facilities and services which can affect the operation of your unit. However, your telephone company must give adequate notice in writing prior to such actions to allow you time for making necessary arrangements to continue uninterrupted service.

If you are having trouble with your telephone service, you must first disconnect your telephone to determine if it is the cause of your problem. If you determine that it is the cause, you must leave it disconnected until the trouble has been corrected.

## Radio Interference

Radio interference may occasionally cause buzzing and humming in your cordless handset, or clicking noises in the base unit. This interference is caused by external sources such as TV, fluorescent lighting, or electrical storm. Your unit is NOT DEFECTIVE. If these noises continue and are too distracting, check around your office to see what appliances may be causing the problem. In addition, we recommend that the base not be plugged into a circuit that also powers a major appliance because of the potential of interference. For best performance, ensure that the antenna on the base unit is fully extended.

In the unlikely event that you consistently hear other voices or distracting transmissions on your telephone, you may be receiving radio signals for another cordless telephone or other source of interference.

Finally, it should be noted that some cordless telephones operate at frequencies that may cause interference to nearby TVs and VCRs. To minimize or prevent such interference, the base of the cordless telephone should not be placed near or on top of a TV or VCR. If interference is experienced, moving the cordless telephone farther away from the TV or VCR will often reduce or eliminate the interference.

### **More than One Cordless Telephone**

If you want to use more than one cordless telephone in your office, they must operate on different channels and more than 20 feet apart.

If more than eight DTL-8R-1s are used in the same area, there is a possibility that the following problem occurs:

- Difficulty connecting the Handset with the Base Unit
- Some noises can be heard during conversation

The DTL-8R-1 is limited to five RF channels. The RF channel is changed automatically to find the best channel.

Depending on your environment, the maximum number of cordless devices used without interference varies.



Multiple base and handset units should not be closer than 20 feet at any time.

Radio interference causes interruptions in conversation. When this happens, your unit is not defective. When noise continues, move to a different location while you talk. (You might even need to move the base unit.) When the situation persists, contact the National Technical Assistance Center (NTAC).

# CHAPTER 2 *About the D<sup>term</sup> Cordless DECT*

## SECTION 1 OVERVIEW

DTL-8R-1 is a cordless telephone that is adapted for digital NEC PBX (Private Branch Exchange). It is designed for use in the office environment.

-  *The Cordless Handset and wired phone cannot be used at the same time.*
-  *The Handset and Base Station must have the original ID that is written on each unit at the factory.*

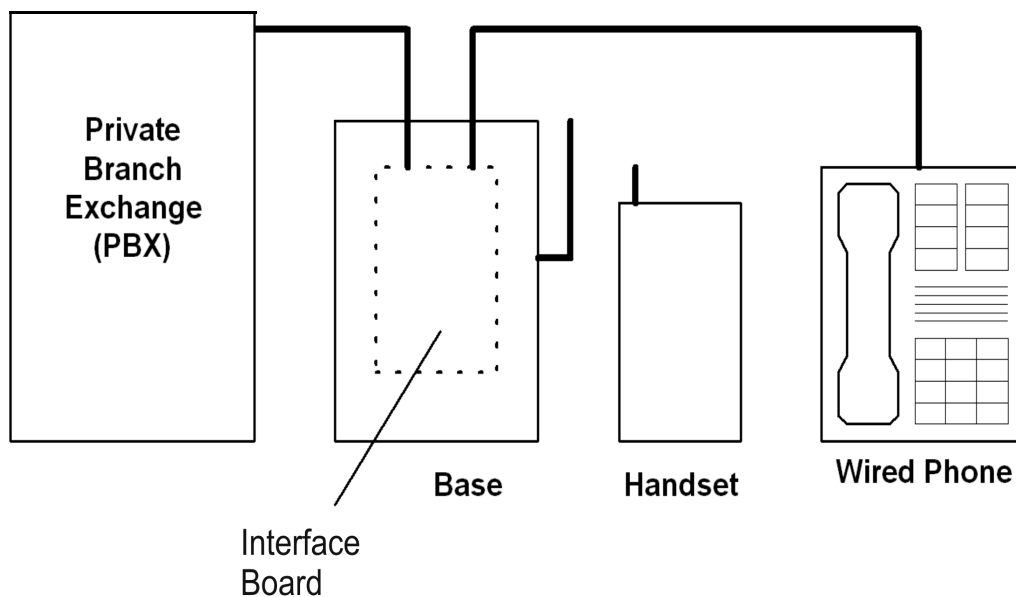
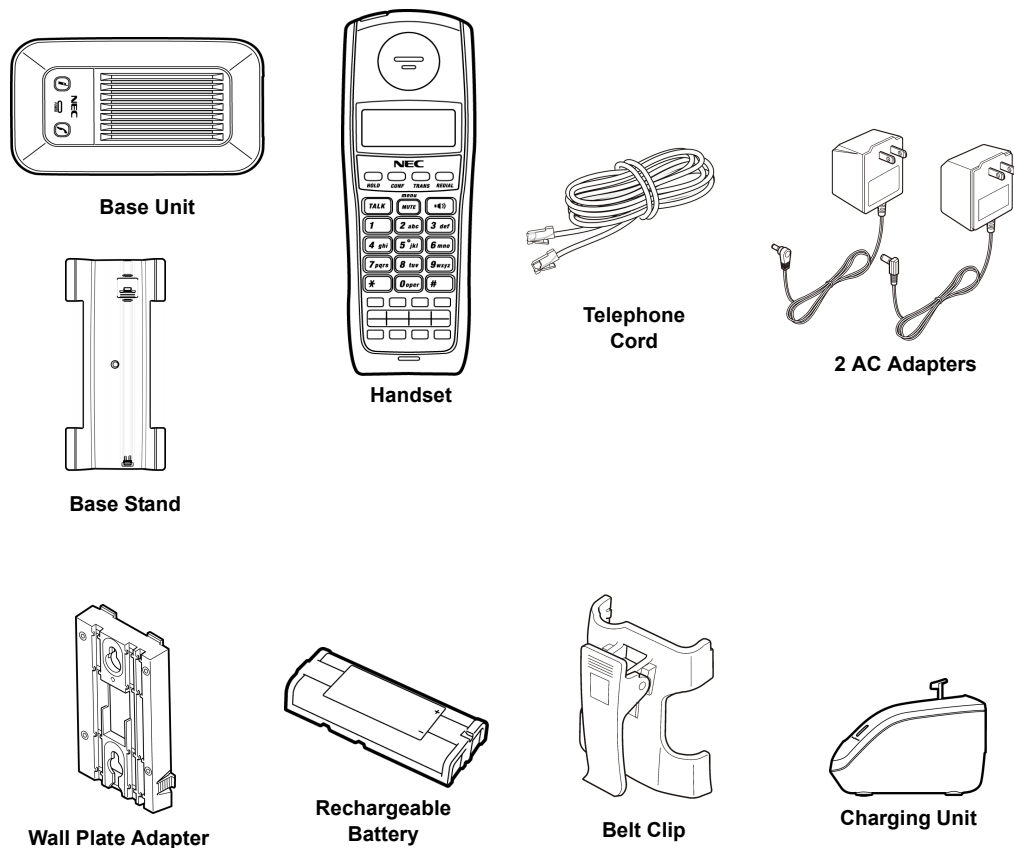

Figure 2-1 System Overview

**SECTION 2      ITEMS INCLUDED WITH THE *D<sup>term</sup>* CORDLESS DECT**

Congratulations on your purchase of the *D<sup>term</sup>* Cordless DECT. This telephone is designed and engineered to exacting standards for reliability, long life, and outstanding performance. To become familiar with the features of the cordless telephone, read this manual thoroughly.

The *D<sup>term</sup>* Cordless DECT includes the following items:



**Figure 2-2 Items Included with the *D<sup>term</sup>* Cordless DECT**

### SECTION 3      **FEATURES OF THE CORDLESS TELEPHONE**

The D<sup>term</sup> Cordless DECT provides a variety of features. These features are listed below.

- 1.9G (1920~1930 MHz)
- 5 Channels
- Display:
  - 2 lines, 16-digit LCD
- 8 Programmable Keys: 4 Programmable Keys and 4 One Touch Keys
- Headset Jack
- Mute Control
- AutoStandby<sup>®</sup>
- Separate Charging Stand with Spare Battery Charging Capability
- Handset/Headset/Handsfree Volume Control
- Adjustable Ringer Volume Control
- 6 Selectable Ring Tones
- Vibrating Ringer
- Out of Range Detection and Alarm Tone
- LCD Backlight
- Key Backlight
- Automatic Channel Selection
- Single Key Access to: Conference, Hold, Transfer and Redial features
- Low Battery Protection System
- Wall Mountable Separate Base Unit
- Wall Mountable Separate Charging Unit
- Easy Installation
- Compact Handset Design
- Use with an NEC Digital Multiline Telephone

 *The D<sup>term</sup> Cordless DECT can be used in conjunction with the D<sup>term</sup><sup>®</sup> DTP, DTU, DTH, DTR and DTL Multiline Telephones.*

## SECTION 4 **D<sup>term</sup> CONTROLS AND FUNCTIONS**

The primary components of the D<sup>term</sup> Cordless DECT consist of the handset and the base unit. Before using the telephone for the first time, you should become familiar with the controls and functions of the handset and base unit.

### 4.1 Handset

The handset is used to make/receive calls. The various buttons and LCD provide access to and provide indication of the various functions and operations of the phone. [Figure 2-3 Handset Controls and Functions on page 2-5](#) provides a layout of various controls and functions available with the handset. For a detailed description of the buttons, refer to [Chapter 4 D<sup>term</sup> Handset, Base Unit and Charging Unit, Section 1 Handset Controls on page 4-1](#).

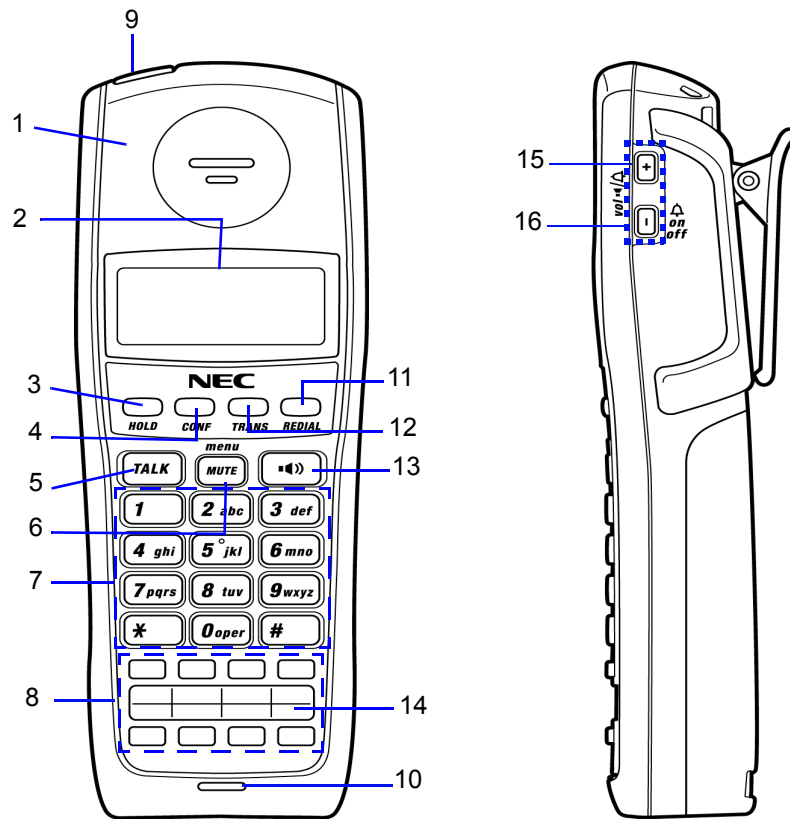

- |   |  |
|---|--|
| 1. DTL-8R-1 Cordless Handset  | 9. Headset Jack  |
| 2. Message Display  | 10. Microphone   |
| 3. Hold ( <b>HOLD</b> ) Key   | 11. Redial ( <b>REDIAL</b> ) Key or Desk/Cordless Softkey Switch Key |
| 4. Conference ( <b>CONF</b> ) Key   | 12. Transfer ( <b>TRANS</b> ) Key                                    |
| 5. Talk ( <b>TALK</b> ) Key   | 13. Handsfree (SP) Key   |
| 6. Mute ( <b>MUTE</b> + Menu) Key   | 14. Programmable Key Labels  |
| 7. Numeric Keypad   | 15. Volume Up/Ringer Volume Key                                      |
| 8. Upper row: Programmable Keys (F1~F4)<br>Lower row: Programmable Keys (F1~F8) | 16. Volume Down/Ringer Mute Key                                      |

**Figure 2-3 Handset Controls and Functions**

## 4.2 Base Unit

The Base Unit allows users to switch between the D<sup>term</sup> Cordless DECT phone and the wired (desk) phone by using the Desk/Cordless buttons on the unit.

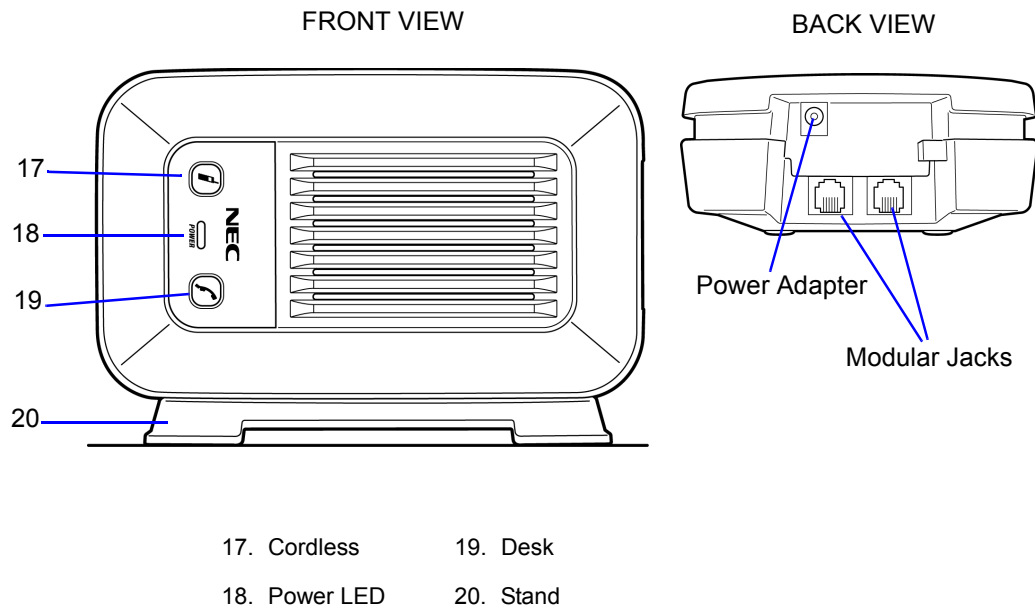

**Figure 2-4 Base Unit Controls and Functions**

## 4.3 Cordless Handset/Desk Phone Switch (Base Key Option)

If Base Key Option is on, One Touch Dial Keys 3 and 4 on the Handset are used to switch between Desk Phone or Handset:

- Press and hold the One Touch Dial 3 key to switch to the Handset (same as the Cordless Key on the Base Unit).
- Press and hold One Touch Dial 4 key to switch to the Desk Phone (same as the Desk key on the Base Unit).

*When the Base Key Option is set, One Touch Keys 3 and 4 cannot be used for One Touch operation.*

### 1. Start Up

Upon powering up (Battery connection) push **2 + 5 keys** to set the Base Key Option setting. The following screen displays along with a confirm tone.



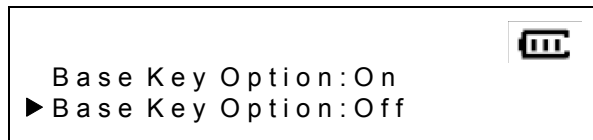

Push the up or down key to select the option. Push the **MUTE(Menu)** key to save the setting. The Handset gives a confirmation tone.

#### 4.4 Charger Unit

The Charger Unit is used to recharge the batteries in the handset.

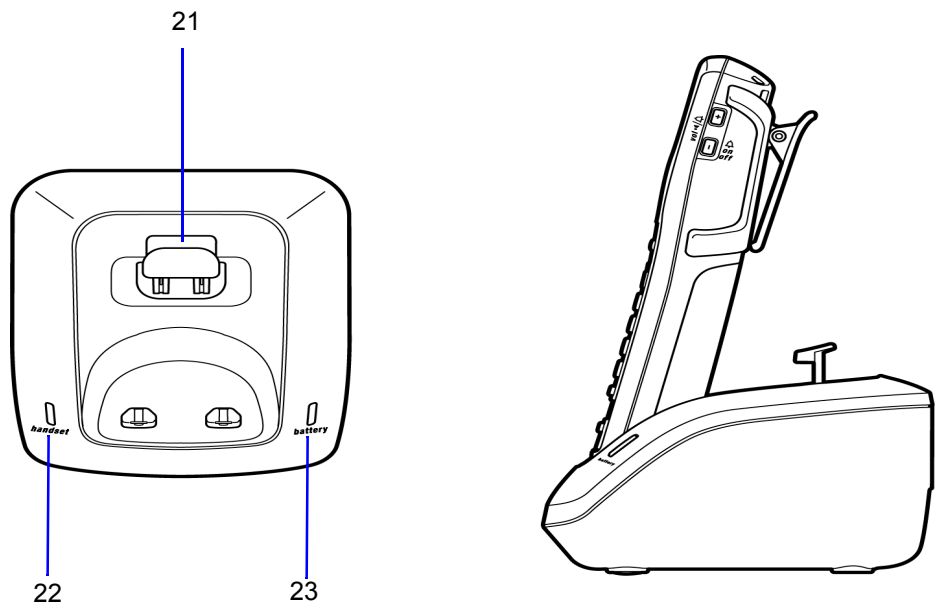

- 21. Battery Lever
- 22. Handset Charging LED

- 23. Optional Battery Charging LED

**Figure 2-5 Charging Unit Controls and Functions**

**THIS PAGE INTENTIONALLY LEFT BLANK**

## CHAPTER 3      *Installation*

---

### SECTION 1      **SELECTING A LOCATION**

Select a location for the D<sup>term</sup> Cordless DECT to avoid excessive heat or humidity. The base unit of the D<sup>term</sup> Cordless DECT can be placed on a desk or tabletop near a standard 120 Vac outlet and telephone line jack. The base unit can also be mounted on a standard wall plate using the wall mount adapter. Keep the base unit and handset away from sources of electrical noise (motors, fluorescent lighting, computers, PC monitor). Refer to [Chapter 1 Specifications and Safety Information](#) for a complete discussion of safety precautions.

### SECTION 2      **INSTALLATION PRECAUTIONS**

To ensure optimum performance follow these guidelines.

- Each base unit must be placed at least 20 feet apart.
- Always place the base unit on top of a desk or on higher shelves. Avoid locations surrounded by metal surfaces.
- Place the base away from any electrical component such as a PC, monitor and other telephone.

### SECTION 3      **CONNECTING THE TELEPHONE CORDS**

When connecting the telephone cords, observe the following precautions.

- Never install telephone wiring during a lightning storm.
- Never touch bare telephone wires or terminals unless the telephone line has been disconnected at the network interface.
- Use caution when installing or modifying telephone lines.

To connect the telephone cords:

1. Connect the cord from the telephone jack to the Line In on the D<sup>term</sup> Cordless DECT.

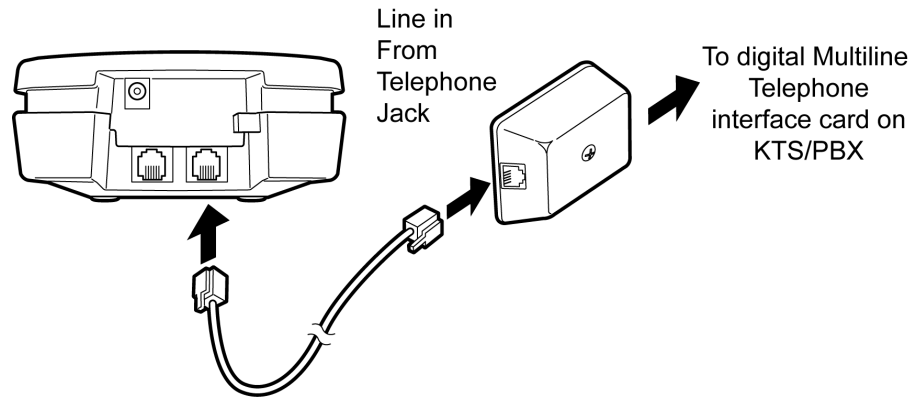

**Figure 3-1 Connecting Telephone Cords to the Telephone Jack**

2. Connect a qualified NEC digital Multiline Terminal to the D<sup>term</sup> Cordless DECT.

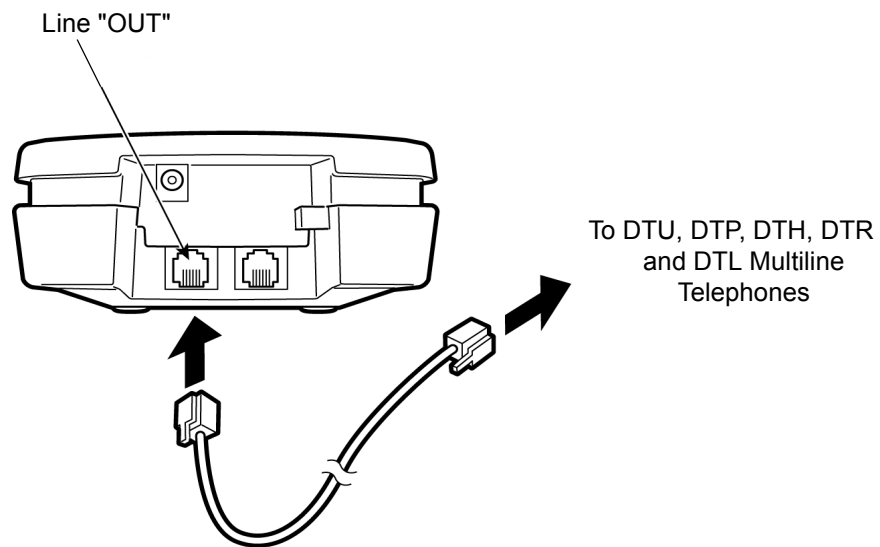

**Figure 3-2 Connecting the D<sup>term</sup> Cordless DECT to the Multiline Terminal**

## SECTION 4 APPLYING POWER TO THE CHARGING UNIT

The unique design of the telephone allows the user to place the handset in the charging unit with or without the belt clip attached. The charging unit can charge a second battery with or without the handset being charged. The battery packs can automatically be recharged either in or out of the handset.

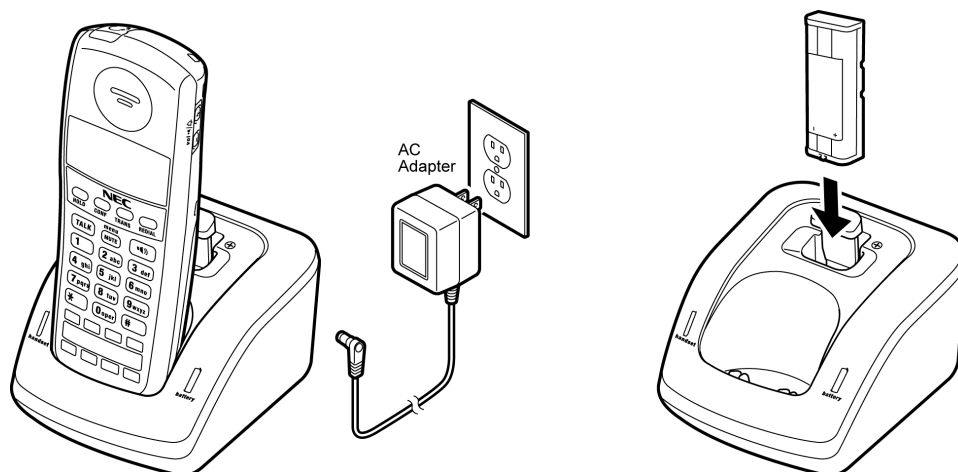

**Figure 3-3 Applying Power to the Charging Unit**



***Use only the supplied AC adapter for the charging unit.***

The AC adapter furnished with this telephone may be equipped with a polarized line plug (a plug having one blade wider than the other). This plug will fit into the power outlet only one way. If you are unable to insert the plug fully into the outlet, try reversing the plug. Refer to [Figure 3-4 Polarized Plug](#).

If you cannot plug the AC adapter into the outlet, the outlet may need to be replaced.



***Route the power cord where it will not create a trip hazard, or where it could become chafed and create a fire or other electrical hazards.***

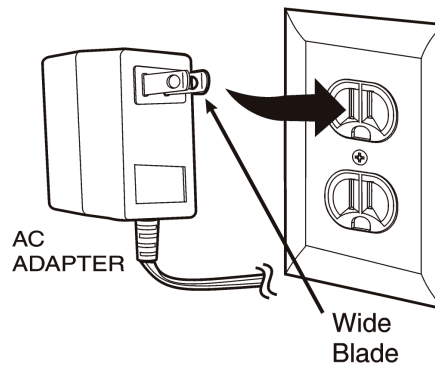

**Figure 3-4 Polarized Plug**

## SECTION 5 WALL INSTALLATION

### 5.1 Mounting the Base to a Standard Wall Plate

The base unit is designed to be mounted on standard wall plate. To attach the wall mount stand to the base unit:

1. Slide the wall mount stand into the notches at the top of the base unit. Rotate the wall mount stand down and snap it into place.

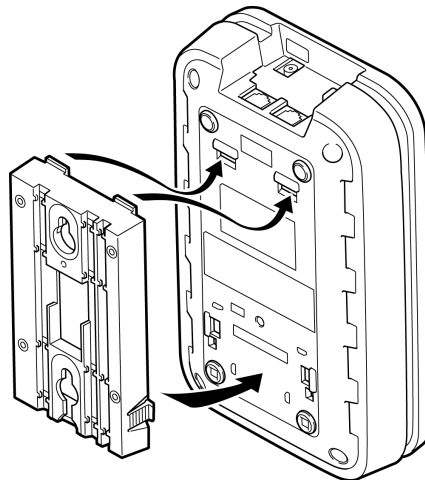

**Figure 3-5 Attaching the Wall Mount Stand to the Base Unit**

2. Plug the AC adapter into the base unit.

3. Place the AC adapter cord inside the molded channel of the wall mount stand.

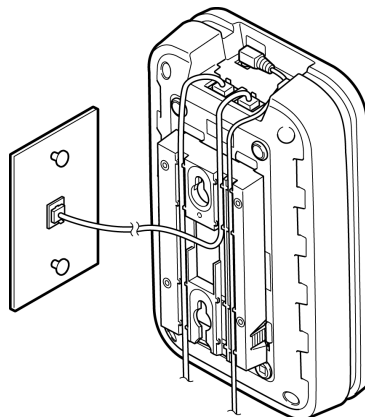

**Figure 3-6 Placing the AC Adapter Cord Inside the Wall Mount Stand**

4. Plug one end of the short telephone cord (locally supplied) in the **LINE** jack on the base unit. Plug one end of the NEC digital multiline telephone into the **PHONE** jack. Place the telephone cords inside the molded channels on the bottom of the wall mount stand.
5. Plug the other end of the short telephone cord into the modular wall jack in the center of the wall plate.
6. Place the base unit on the posts of the wall plate and push down until it is firmly seated.

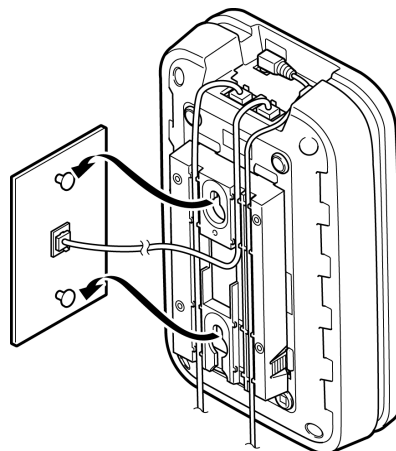

**Figure 3-7 Placing the Base Unit on the Posts of the Wall Plate**

7. Plug the AC adapter into a standard 120 Vac wall outlet.

 Do not use an outlet controlled by a wall switch.

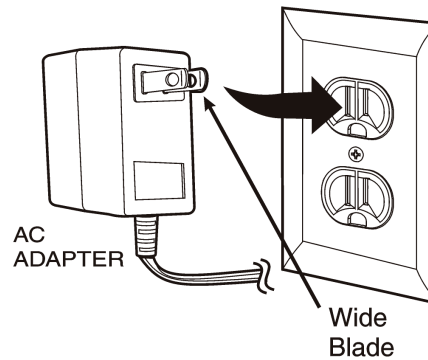

**Figure 3-8 Plugging the AC Adapter into the AC Wall Outlet**

## 5.2 Mounting the Base Directly to the Wall

If a standard wall plate is not available, mount the telephone directly on the wall. Before mounting the telephone, consider the following:

- Select a location away from electrical cables, pipes, or other items behind the mounting location that could cause a hazard when inserting screws into the wall.
- Make sure the wall material is capable of supporting the weight of the base unit.
- Use #10 screws with anchoring devices suitable for the wall material where the base unit will be placed.

To mount the telephone:

1. Insert two mounting screws 3-15/16" apart. Allow 3/16" between the wall and screw heads for mounting the telephone.



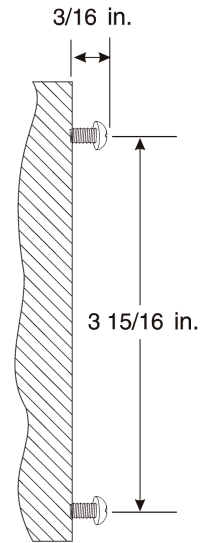

**Figure 3-9** Inserting Screws into the Wall for Wall Mounting the Telephone

2. Plug in and secure the AC adapter.
3. Plug the AC adapter into the base unit.
4. Plug one end of the short telephone cord into the **LINE** jack on the base unit. Then plug one end of an NEC multiline telephone into the **PHONE** jack. Place the telephone cords inside the molded channels on the bottom of the wall mount stand.

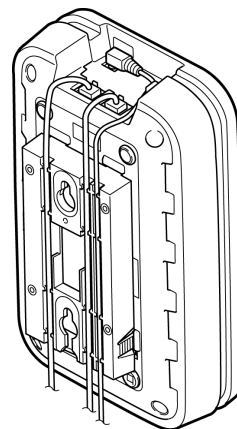

**Figure 3-10** Placing the Telephone Cords Inside the Wall Mount Stand

5. Place the base unit on the posts of the wall screws and push down until it is firmly seated.

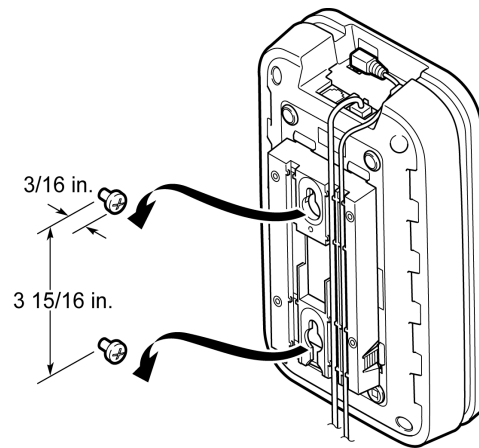

**Figure 3-11 Attaching the Wall Mount Unit to the Wall**

6. Plug the other end of the short telephone cord into a telephone wall jack.
7. Plug the AC adapter into a standard 120 Vac wall outlet. Refer to [Figure 3-8 Plugging the AC Adapter into the AC Wall Outlet on page 3-6](#).
  - ✎ Do not use an outlet controlled by a wall switch.

### 5.3 Wall Mounting the Charging Unit

The charging unit is also designed to be wall mounted. Before mounting the charging unit, consider the following:

- Select a location away from electrical cables, pipes, or other items behind the mounting location that could cause a hazard when inserting screws into the wall.
- Make sure the wall material is capable of supporting the weight of the charging unit.
- Use #10 screws with anchoring devices suitable for the wall material where the charging unit will be placed.

To mount the charging unit:

1. Insert two mounting screws 1-7/8" apart. Allow 3/16" between the wall and screw heads for mounting the telephone.

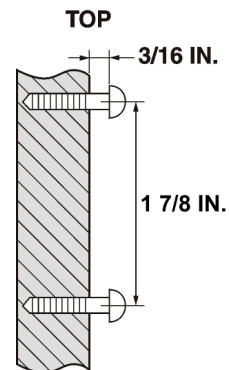

**Figure 3-12 Inserting Screws for Wall Mounting**

2. Plug the AC adapter into the charging unit. Wrap the AC adapter cord around the strain relief.

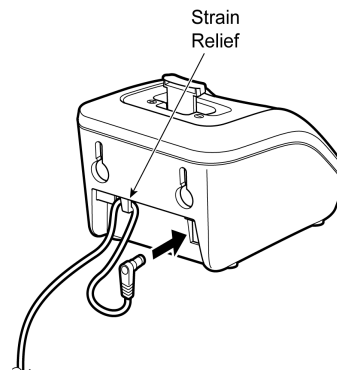

**Figure 3-13 Wrapping the AC Adapter Cord Around the Strain Relief**

3. Place the charging unit on the posts of the wall screws and push down until it is firmly seated.

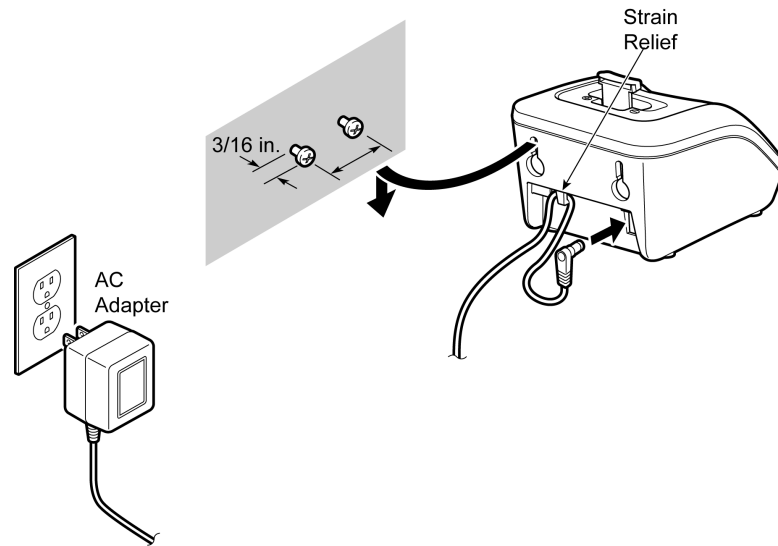

**Figure 3-14 Placing the Charging Unit on the Wall**

4. Plug the AC adapter into a standard 120 Vac wall outlet. Refer to [Figure 3-14 Placing the Charging Unit on the Wall](#).

## SECTION 6 ATTACHING AND REMOVING THE BELT CLIP

A belt clip can be used to attach the handset to a belt or pocket for convenient portability.

1. Slide the clip into the tab slots. Press firmly until it snaps into place. The belt clip is designed to fit snugly onto the handset.

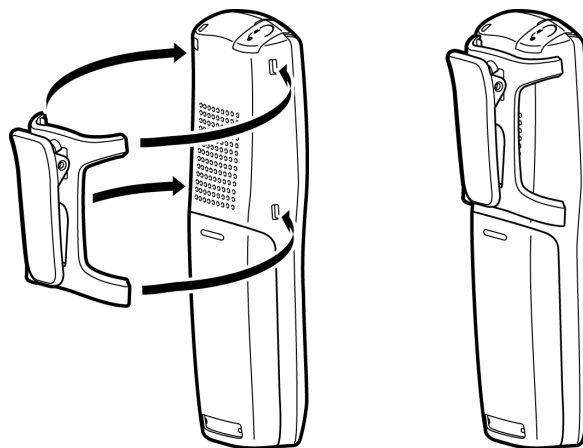

**Figure 3-15 Attaching the Belt Clip to the Handset**

2. To remove the clip, press the retaining clip in toward the belt clip blade and slide the clip up at the same time.

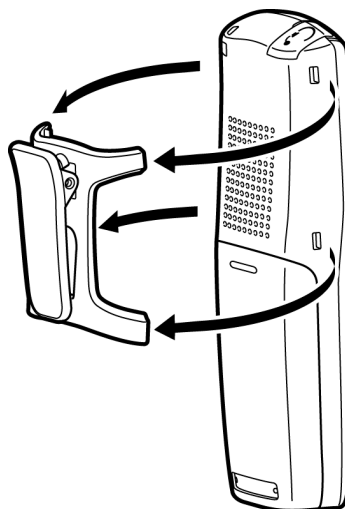
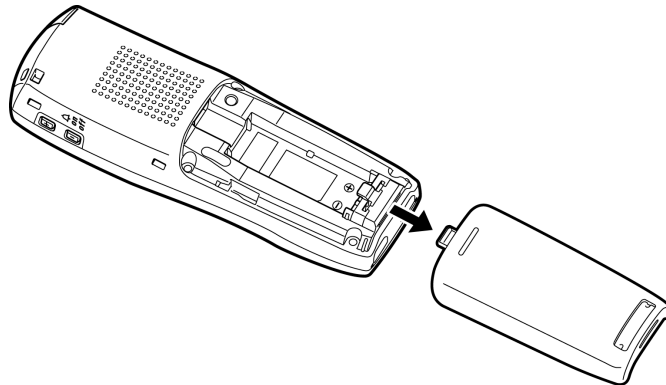

**Figure 3-16 Removing the Belt Clip**

## SECTION 7      INSTALLING THE HANDSET BATTERY PACK

Before installing batteries, refer to [Chapter 1 Specifications and Safety Information, Section 2 Battery Safety on page 1-2](#). It is important to follow safety regulations when handling batteries.

1. Remove the battery cover by pressing the latch and sliding the cover down and off of the handset.



**Figure 3-17 Removing the Battery Cover**

- Slide the battery pack down into the handset.

 *It may be necessary to remove the old battery at this time.*

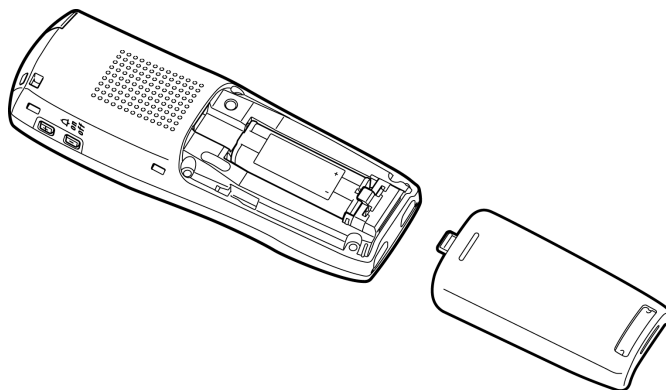

**Figure 3-18 Replacing the Battery Pack**

- Replace the cover and slide it up until it latches onto the handset.

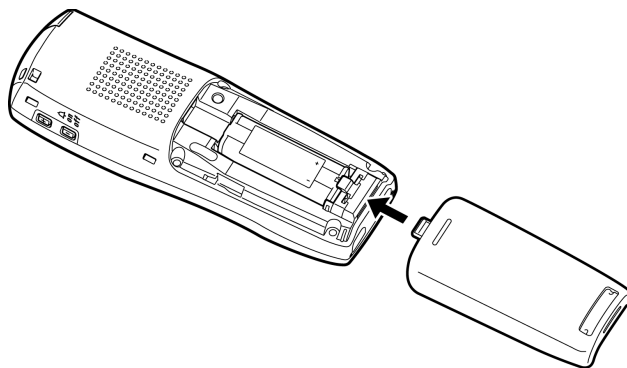

**Figure 3-19 Replacing the Battery Cover**

## SECTION 8 CHARGING BATTERIES

### 8.1 Charging the Handset Battery Pack

The rechargeable battery pack must be fully charged before using the D<sup>term</sup> for the first time.

 *Charge the battery pack without interruption for at least 10 hours.*

- Place the handset in the front slot of the charging unit.

2. Make sure the **Handset Charging** LED indicator lights. If the **Handset Charging** LED does not come on, check to see if the AC adapter is plugged in and that the handset is making good contact with the charging contacts on the charging unit.

*The **Handset Charging** LED turns blue during and after charging the handset with the battery.*

## 8.2 Charging Spare Battery Packs

The D<sup>term</sup> Cordless DECT is equipped with a battery slot for charging a spare battery pack.

1. Slide the spare battery pack into the second slot in the charging unit until the retaining clip snaps over the top of the pack.
2. Make sure the **Optional Battery Charging** LED lights. If it does not light, check that the AC adapter is plugged in and that the battery pack is making contact with the charging contacts on the charging unit.
3. Charging is complete when the **Optional Battery Charging** LED goes off.

*Charge the battery pack without interruption for 16 to 20 hours. The additional charging time is needed because the charging current is different than that of the Handset battery.*

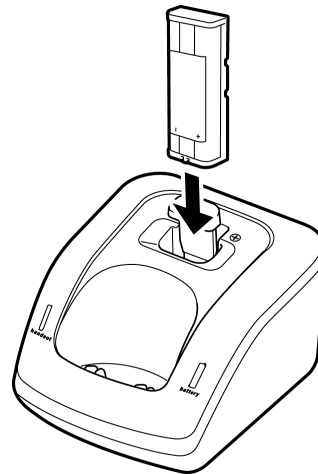

**Figure 3-20 Charging the Battery Pack**

4. When charging is complete, press on the lever and remove the battery pack. If the battery pack is not needed immediately, leave it in the charging compartment (it will not overcharge).



## SECTION 9      LOW BATTERY INDICATOR

### 9.1      Low Battery

The handset has visual and audible indicators to warn of a low battery condition.

#### 9.1.1      In Standby Mode

The Battery Status icon in the LCD changes to battery low.  
The “Charge Battery” message blinks on the LCD (ON: 600msec, OFF: 600msec).

#### 9.1.2      In Talk Mode

The Battery Status icon in the LCD changes to battery low.  
The Handset remains in Talk Mode and the battery low alert tone is emitted every 30 seconds.

#### 9.1.3      In Other Mode (Excluding Standby Mode and Talk Mode)

The Battery Status icon in the LCD changes to battery low.

### 9.2      Battery Status

The LCD shows the battery charge status according to the remainder capacity of the battery.

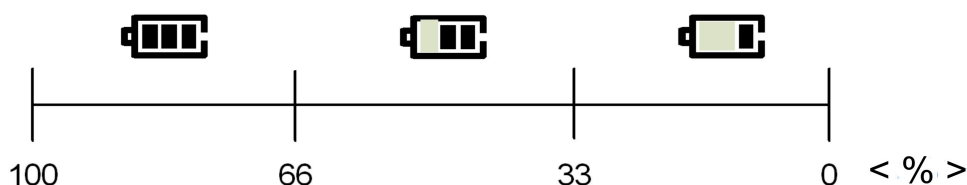

When you receive the low battery indication, return the handset to the charger unit for charging, or replace the handset battery pack with another charged battery pack. Refer to [Section 8 Charging Batteries on page 3-13](#) or [Section 7 Installing the Handset Battery Pack on page 3-12](#).

The following table indicates what occurs and the action to be taken during a call or in Standby Mode when low battery indication is displayed.

On a Call	In Standby Mode
What occurs when <b>Battery icon</b> message blinks:	
Handset beeps once every 30 seconds	<b>Charge Battery</b> message blinks
Action:	
Complete the call as quickly as possible	Replace the battery pack or return the handset to the charger unit.
Battery pack hot swap is not available for this model. Return to charger.	

## SECTION 10 CLEANING THE BATTERY CHARGER CONTACTS

To maintain a good charge, it is important to clean all charging contacts on the handset and charging unit about once a month. Use a pencil eraser or other contact cleaner. Do not use liquids or solvents.

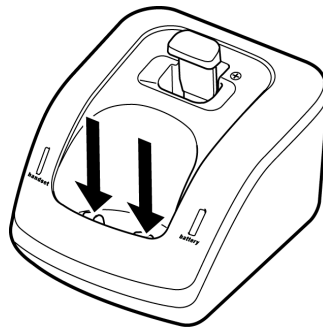

**Figure 3-21** Cleaning Battery Charger Contacts

# CHAPTER 4 *D<sup>term</sup> Handset, Base Unit and Charging Unit*

---

## SECTION 1 **HANDSET CONTROLS**

The operations of the D<sup>term</sup> Cordless DECT are performed using the handset. The **HOLD**, **CONF** (conference), **TRANS** (transfer), **REDIAL**, **TALK**, **MUTE** and ringer volume are located on the handset and are used to control various functions. Volume and Ring control keys are located on the side of the handset.

Refer to [Figure 4-1 Handset Controls](#) for a diagram of the Handset controls and to [Table 4-1 Handset Control Functions](#) on page 4-2 for an explanation of the Handset controls.

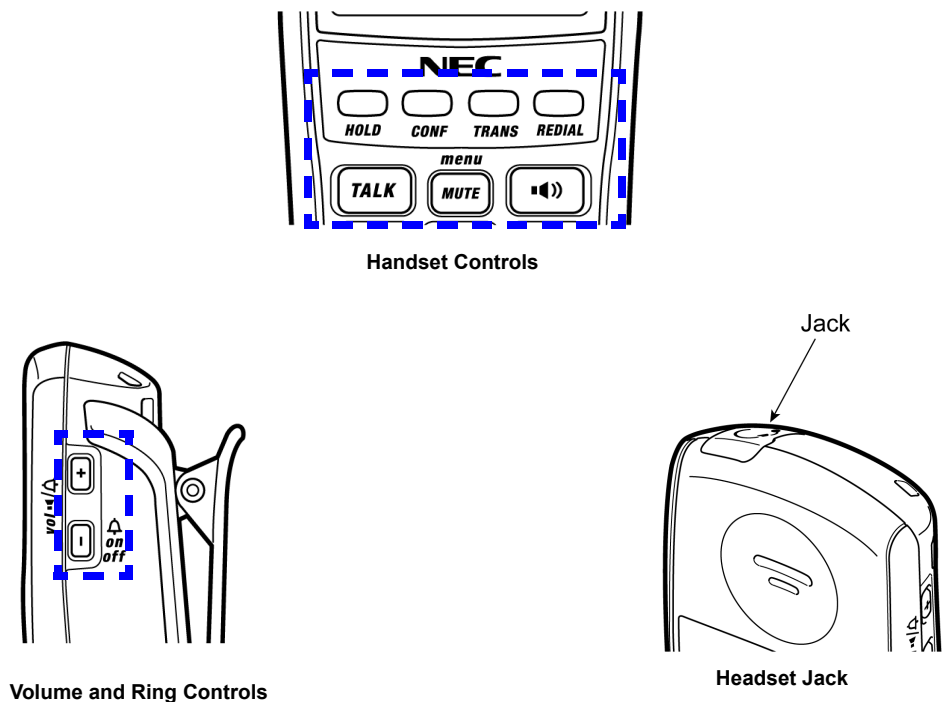











Figure 4-1 Handset Controls

Table 4-1 Handset Control Functions

Condition	Action
 <b>HOLD</b>	Press <b>HOLD</b> on the front of the handset to place an existing call on hold.
 <b>CONF</b>	Press <b>CONF</b> on the front of the handset to add a call to a conference.
 <b>TRANS</b>	Press <b>TRANS</b> on the front of the handset to transfer a call
 <b>REDIAL</b>	Press <b>REDIAL</b> on the front of the handset to dial the number that was previously dialed. <input type="checkbox"/> Up to 32 digits
 <b>TALK</b>	Press <b>TALK</b> on the front of the handset to make a call. The telephone first acquires a connection to the base. Press <b>TALK</b> key in Menu Mode to cancel menu setting.
 <b>MUTE</b>	Press <b>MUTE</b> (Menu), located on front of the handset, to mute a conversation. Press <b>MUTE</b> (Menu) in Standby Mode, the Handset displays the user menu window. Press <b>MUTE</b> (Menu) in Conversation Mode to mute the microphone. The <b>MUTE</b> (Menu) button toggles to turn the microphone muting function on and off. When the conversation ends, muting is turned off.
	Press the <b>Speaker</b> key, on the front of the handset, in Standby Mode or during Talk Mode to turn on Handsfree Mode and talk handsfree. Will not toggle on and off between Talk Mode and Handsfree Mode. For example, "Press the <b>Speaker</b> key in Standby Mode or Conversation Mode to turn on Handsfree Mode." And also "Press the <b>Speaker</b> key in Menu Mode to cancel menu setting." When the handset is in Handsfree Talk Mode, the Handsfree icon displays on the LCD of the handset. When the <b>Speaker</b> key is pressed during Handsfree Talk Mode, the conversation is ended and the handset goes into On-Hook Mode.

**Table 4-1 Handset Control Functions**

Condition	Action
Ringer Volume Key 	Press the Ringer Up/Ringer Volume key on the side of the handset to increase the volume level during the Standby Mode: <input type="checkbox"/> OFF-Vibrate <input type="checkbox"/> Low <input type="checkbox"/> High The LCD displays the current volume setting for two seconds. If Ringer is set to OFF-Vibrate while in the charging cradle, the headset will ring low.
Ringer Volume Key 	Pressing and holding the Ringer Down/Ringer Mute key, on the left side of the handset, mutes the Ringer. During the ring cycle, press and hold this key to mute the ringer.
Headset Jack	Insert the Headset plug into the handset jack during Talk or Handsfree Mode. Use corresponding handset keys to activate headset.

## SECTION 2 BASE UNIT CONTROLS

The Base Unit allows users to switch between the D<sup>term</sup> Cordless DECT phone and the wired (desk) phone by using the Desk/Cordless buttons on the unit.

The Base Unit has three LEDs. The operation status of the LEDs are listed below.

### Power LED

- Base is powered on: On (Blue LED)
- Base is powered off: Off

### NEC Multiline Terminal LED

Manual press of the button will initialize the NEC multiline terminal.

### Cordless LED

Manual press of the button will switch control to the cordless handset.

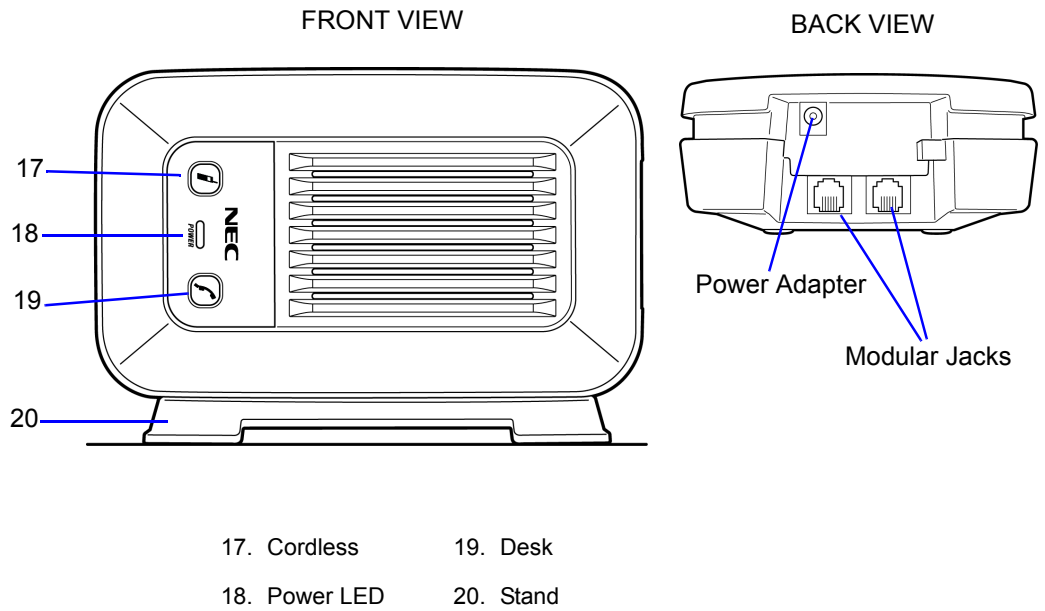

**Figure 4-2 Base Unit Controls and Functions**

## SECTION 3 CHARGER UNIT

The Charger Unit is used to recharge the batteries in the handset.

The Charger Unit has two LEDs. (Refer to [Figure 4-3 Charging Unit Controls and Functions.](#))

### Handset Charging LED

- Handset is on charger: On
- Handset is not on charger: Off

### Optional Battery Charging LED

- Second battery is in charger: On
- Second battery is not in charger: Off

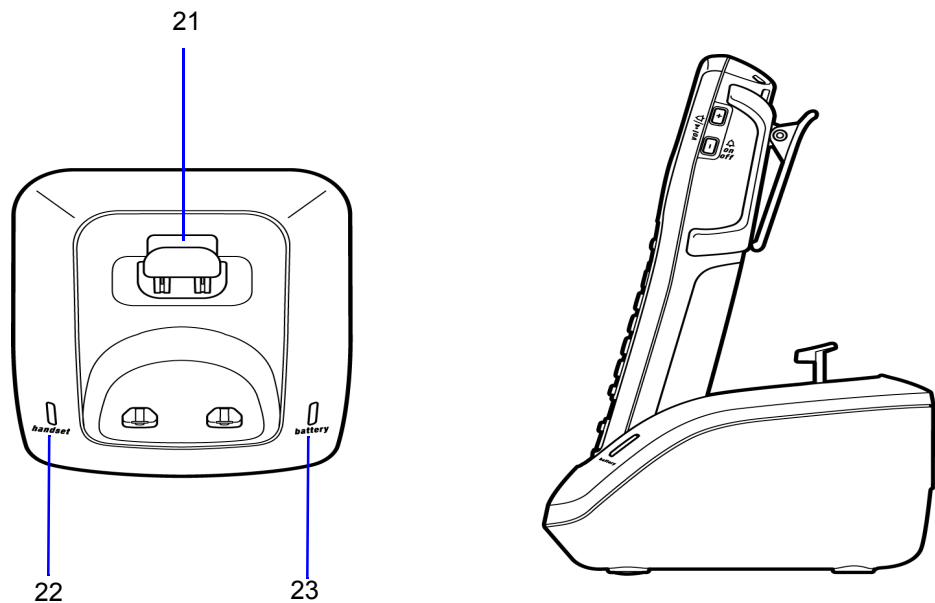

21. Battery Lever  
22. Handset Charging LED

23. Optional Battery Charging LED

**Figure 4-3 Charging Unit Controls and Functions**

**THIS PAGE INTENTIONALLY LEFT BLANK**



# CHAPTER 5 *Optional Equipment Installation*

---

## SECTION 1 **OPTIONAL ACCESSORIES AND REPLACEMENT PARTS**

Optional accessories and replacement parts can be obtained by contacting your NEC representative.

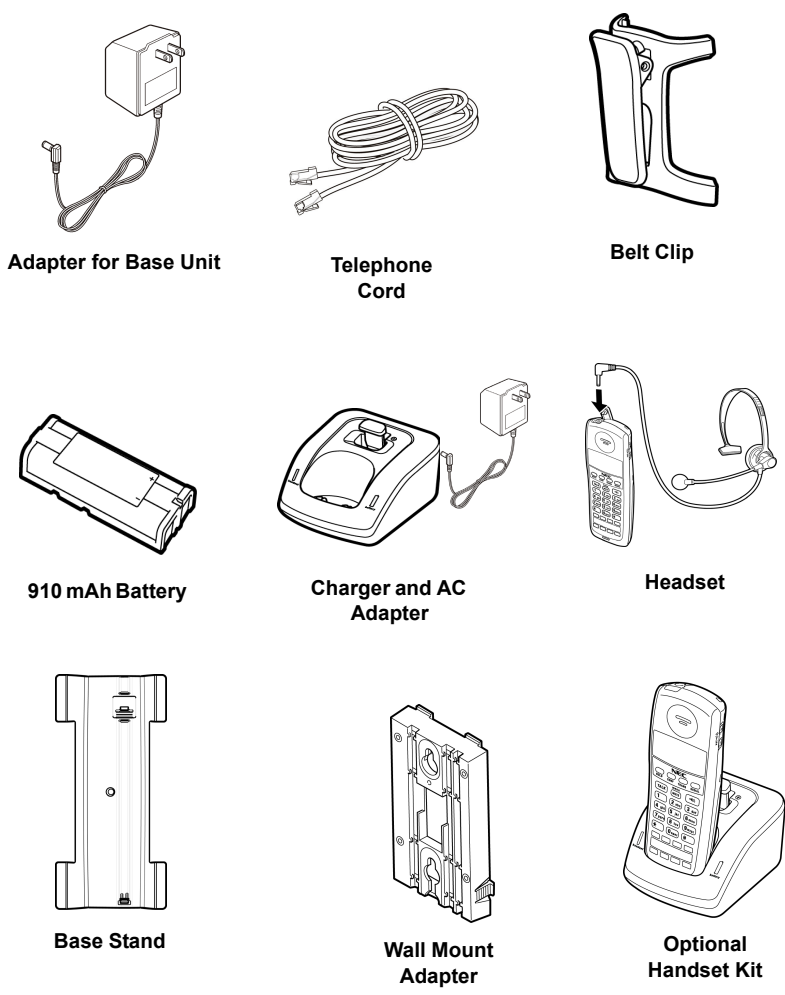

**Figure 5-1** Optional Accessories and Replacement Parts

## SECTION 2      **INSTALLING THE OPTIONAL HEADSET**

The optional headset provides a handsfree option for the D<sup>term</sup> Cordless DECT. With the headset installed, the user can use the belt clip to carry the handset and conduct a conversation using the headset.

To install the headset:

Open the cover over the headset jack and plug the headset into the receptacle.

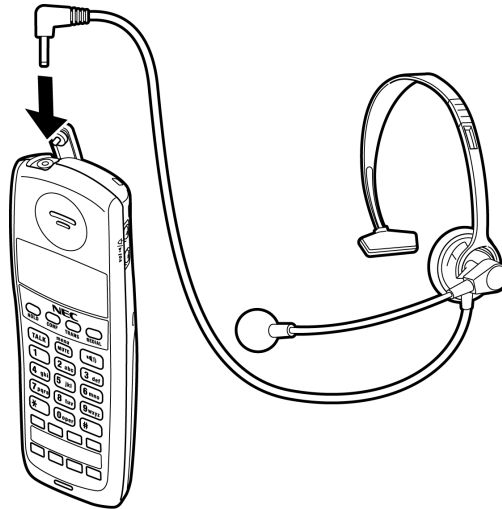

**Figure 5-2 Installing the Headset**

No other settings are needed. Operation of the headset is the same as the handset. However, the user hears through the headset earphone and talks through the headset microphone. The handset earphone and microphone (mouthpiece) are disconnected.

 *Talk or Speaker key will be used to activate the headset.*

## SECTION 3      **INSTALLING THE OPTIONAL DTL-8R HANDSET KIT**

The D<sup>term</sup> Cordless DECT Handset Kit offers the ability to add a second handset to a DTL-8R-1 D<sup>term</sup> Cordless DECT terminal. The Dual Handset option is ideal for the SOHO office environment.

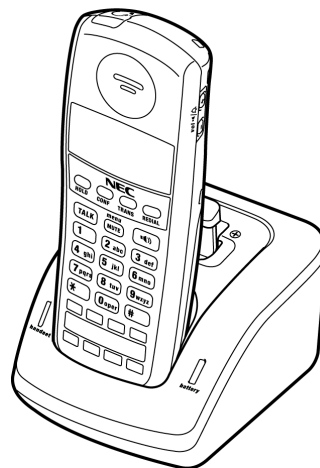

**Figure 5-3 Optional DTL-8R Handset**

### **3.1 Limitations**

- Only one handset can be in use at a time.
- While one handset is in an active call, the second handset will not be able to accept or make outgoing calls.
- Both handsets share the same extension number.
- Base unit version must have firmware **Version 7.2 or higher** (this is listed on the under side of the base unit).
- Base hardware needs to be **Revision C or higher**.

### **3.2 Conference**

While one handset is in an active call the second handset can be conferenced into the existing call.

1. Press the **menu/Mute** key on the active handset.

2. The mute icon will be displayed.

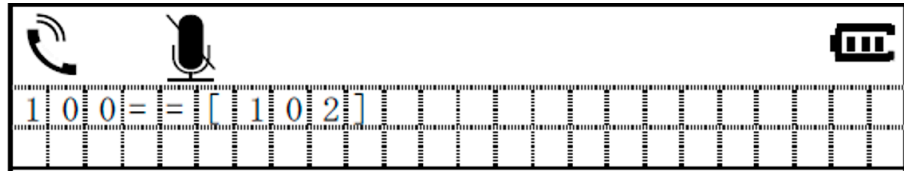

3. Press the **TALK** or the **Speaker** key on the inactive handset that you would like to enter the conference.
4. Press the **menu/Mute** key on the 1st active handset to establish the conference.

### 3.3 Transfer a Call to the Other Handset

A DTL-8R handset in an active call can transfer the call to the other paired handset.

1. Press **menu/Mute** key on the active handset.
2. The mute icon will be displayed.

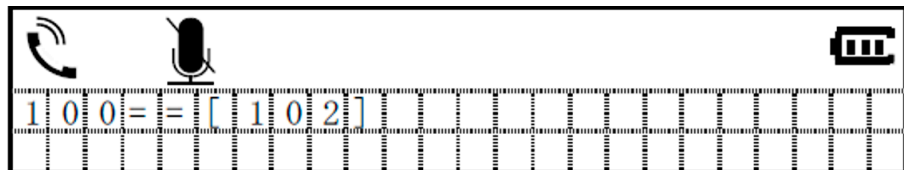

3. Press the **TALK** or **Speaker** key on the inactive handset that you would like the active call transferred to.
4. Press the **TALK** or **Speaker** key on the 1st active handset to complete the transfer.

### 3.4 Registering a Second Handset to the Base Unit

Follow the steps below to register a second handset to the D<sup>term</sup> Cordless DECT base unit.

#### 3.4.1 View and Record the Base Registration PIN

1. Press the **menu/Mute** key in standby mode of the registered handset.

2. Select "Base Registration PIN" by pressing the volume **up** or **down** keys, then press the **menu/Mute** key to enter the selection.



3. Confirm the 4 digit Pin Number and press the **menu/Mute** key.

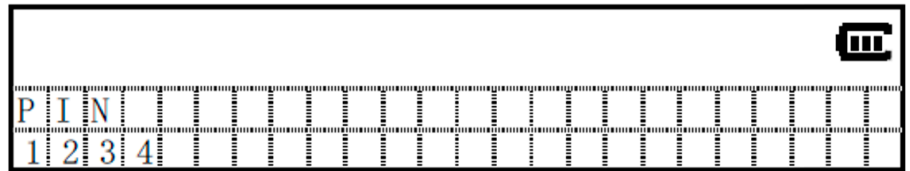

4. Use the volume **up** or **down** keys to Exit.

#### 3.4.2 Registration of the Second Handset

1. Press the **menu/Mute key** when in the standby mode or the LCD is showing "Not Registered".
2. Select "Register" by pressing the volume **up** or **down** keys and press the **menu/Mute** key to enter the selection.



3. Press the Cordless Handset Key on the base unit and hold for three seconds. The Power LED will begin to blink (on:300msec, Off:300msec) for one minute.

4. When the LCD displays the following message, enter the previously recorded Base PIN number.



5. The handset is registered to the Base Station after the LCD displays the following message.

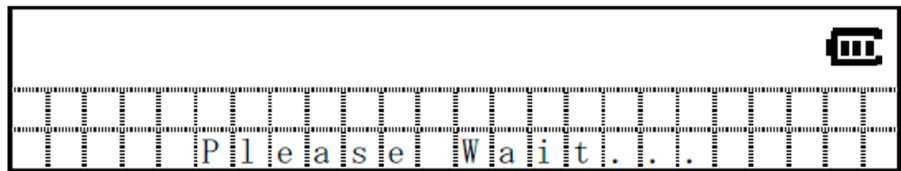

# CHAPTER 6 *Setup and Operation*

---

## SECTION 1 **SETTING UP AND PROGRAMMING THE DTL-8R-1**

### 1.1 **Programming Mode**

#### 1.1.1 Training Mode (Entry)

To enter Training Mode:

Press and hold \* and # at the same time and then press the **TALK** key. The Handset emits a confirmation tone and enters Training Mode. The following message is displayed on the LCD and the F1 LED blinks.

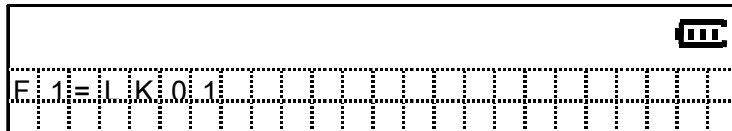

#### 1.1.2 Training Mode (**Volume Down** key: Select Item)

To select an item use the **down** key as illustrated in the following displays.

F. 1 = I. K. 0. 1

▼ press down key

F. 1 = I. K. 0. 1 / T. A. I. K

▼ press down key

F. 2 = I. K. 0. 2

▼ press down key

F. 2 = I. K. 0. 2 / T. A. I. K

▼ press down key

F. 3 = I. K. 0. 3

▼ press down key

F. 3 = I. K. 0. 3 / T. A. I. K

▼ press down key

F. 4 = I. K. 0. 4

▼ press down key

F. 4 = I. K. 0. 4 / T. A. I. K

▼ press down key

OFF-HOOK RING  
= ON

▼ press down key

F. 1 = I. K. 0. 1



## 1.1.3 Training Mode (Volume Up Key – Change Each Item Setting)

The **up** key can change each item setting as illustrated in the following displays (e.g., when the **F1** setting is changed, the F1 LED blinks).

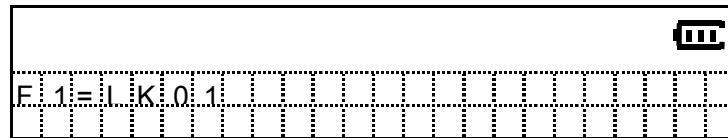

▼] press up key

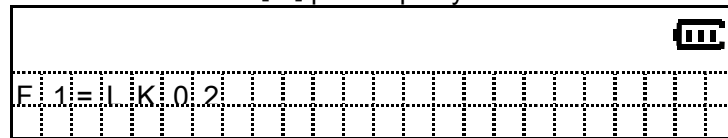

▼] press up key

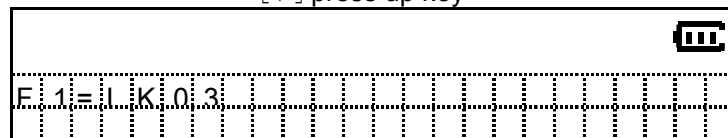

▼] press up key

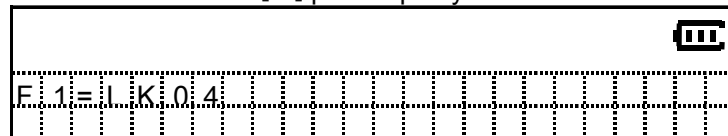

▼] press up key

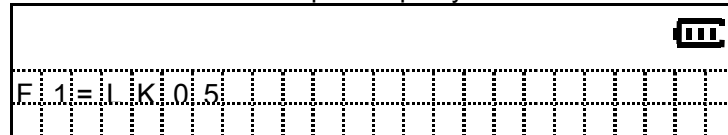

▼] press up key

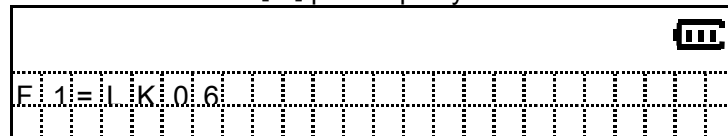

▼] press up key

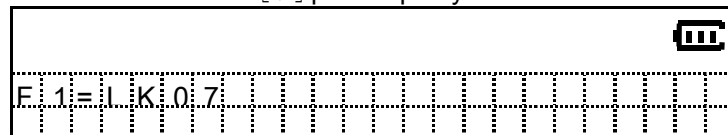

▼] press up key

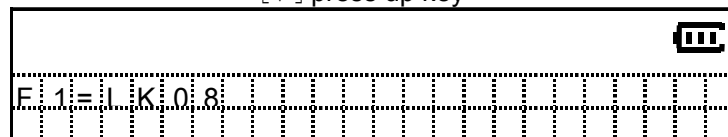

▼] press up key

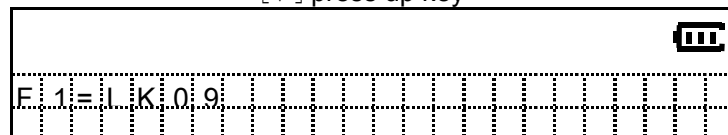

▼] press up key

  
F.1 = I.K. 1.0

▼ press up key

  
F.1 = I.K. 1.1

▼ press up key

  
F.1 = I.K. 1.2

▼ press up key

  
F.1 = I.K. 1.3

▼ press up key

  
F.1 = I.K. 1.4

▼ press up key

  
F.1 = I.K. 1.5

▼ press up key

  
F.1 = I.K. 1.6

▼ press up key

  
F.1 = I.N.R./S.P.D.

▼ press up key

  
F.1 = R.e.c.a.l.l.

▼ press up key

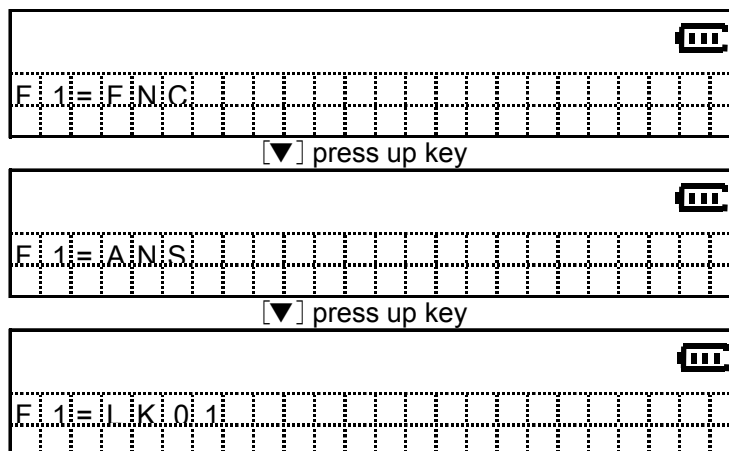

#### 1.1.4 Training Mode (0 Key – No Function)

When 0 is dialed during Training Mode, a key touch tone is emitted and the functions do not work (e.g., NEC PBX).

#### 1.1.5 Training Mode (**TALK** Key or **Speaker** Key – Exit from the Training Mode)

When the **TALK** key or **Speaker** key is pressed at any time during Training Mode, a key touch tone will be emitted and the “Training off” command is sent to the PBX Expansion board. The Handset exits from Training Mode.

## SECTION 2 NEC PBX OPERATION

This operation is one of the examples for the DTL-8R-1 with an NEC PBX. As a result, it might be different from actual operation on your system. Operation of DTL-8R-1 in digital mode depends on each PBX specification.

## 2.1 Switching Between the Wired Phone and Cordless Phone (DTL-8R-1 Handset)

Press the Base Left key to change to the cordless phone (DTL-8R-1 Handset). When the cordless phone is selected, there is no message on the LCD. Press the Base Right key to change to the wired phone. When the wired phone is selected, the LCD shows 'DESK TEL'.

Base Left Key

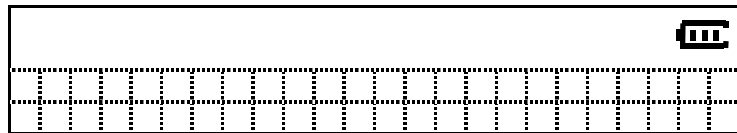

Base Right Key

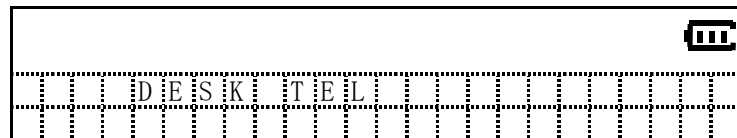

If the Base Key Option is on, One Touch Dial 3 and 4 keys on Handset are used to switch between Desk Phone or Handset.

 In this mode, One Touch Dial 3 and 4 keys cannot be set as One Touch keys.

### 1. Start Up

Upon powering up (Battery connection) push **2 + 5 keys** to enter the Base Key Option setting. It displays the following along with a confirmation tone.

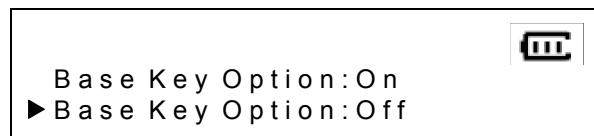

Push the up or down key to select. Push the **MUTE**(Menu) key to save the setting. The Handset gives a confirmation tone.

## 2.2 Making a Call to Another Extension

To make a call to another extension:

1. Press the **TALK** key on the Handset. The Handset tries to connect to the Base Station while the "ACQUIRING LINK" message blinks on the LCD (ON: 300 msec, OFF: 300 msec).



2. When connected, the Handset goes into Talk Mode and Talk icon is turned on and shows current volume for two seconds. If the PBX sends any message during this time, the LCD shows the message after the volume display.



3. If the user dials 1, 0, 2 the LCD shows the dialed number as they are pressed.

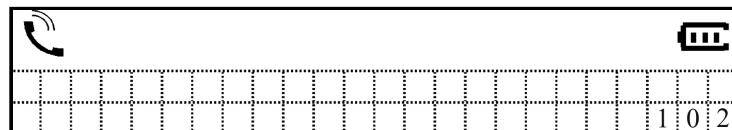

- ✎ When Base Station is not connected to a PBX, the Handset displays "DISCONNECT".

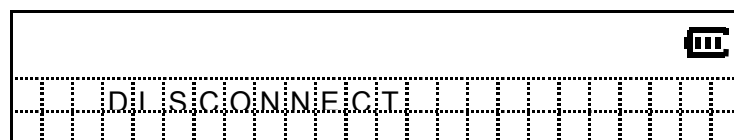

- ✎ When the Handset cannot connect to the Base Station, an error tone is emitted and "Out of Range" is displayed for five seconds on the LCD and the Handset goes into Standby Mode.

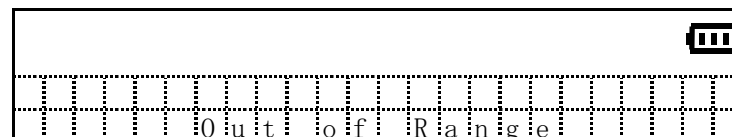

- ✎ The Handset cannot go into Talk Mode when the wired phone is selected.

### 2.3 Making Call to Outside Line

To make an external call:

1. Press the **F1** key or assigned line trunk key on the Handset. The Handset starts to establish an RF connection with the Base Station. The LCD does not change.

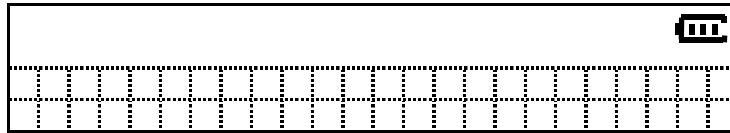

2. When the RF connection is established, the Handset goes into Talk Mode and the Talk icon is turned on. The current volume is shown on the LCD for two seconds and the line key LED is turned on. If the PBX sends any message during this time, the LCD shows the message after the volume is displayed.

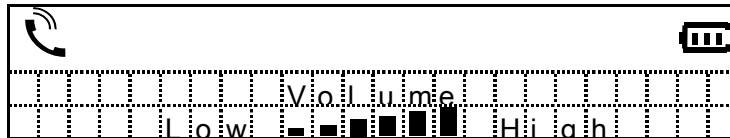

3. The LCD shows this message to prompt the user to dial the numbers.

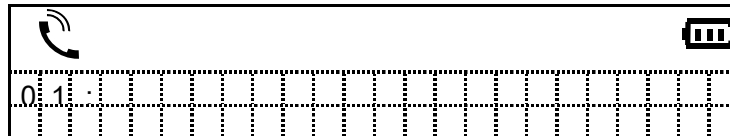

4. If the user dials 1, 2, 3, the LCD shows the dialed numbers in the LCD display.

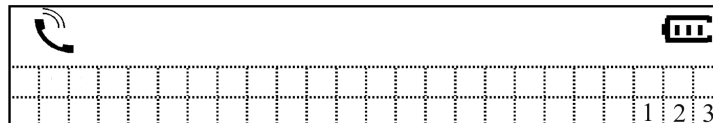

5. About 10 seconds later, the call time is displayed on the LCD.

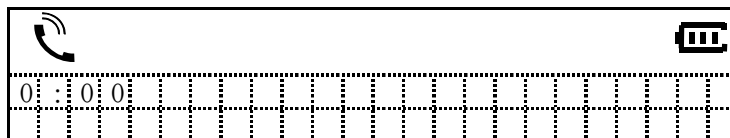

## 2.4 Receiving a Call from an Outside Line (Depends on PBX Line)

To receive a call from an outside line:

1. When an incoming outside line call is received, the Assign Line Key LED blinks.

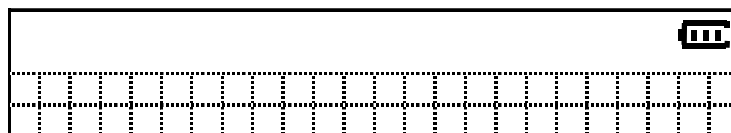

2. If the user presses the Line Key key, the Handset tries to establish and RF connection with the Base Station. However, the "ACQUIRING LINK" message is not shown on the LCD.

*If the user presses the TALK key or dials (0~9, \*, #) or the user picks up the Handset from cradle during this time, the user cannot start a conversation with the outside line calling party.*

3. When RF connection is established, the Handset goes into Talk Mode and turns on the Talk icon. The current volume on the LCD is displayed for two seconds. If the PBX sends any message during this time, the LCD shows the message after the volume is displayed.



4. At the start of the conversation, the following message is displayed.

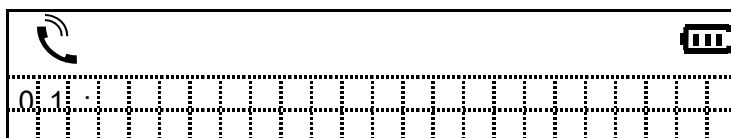



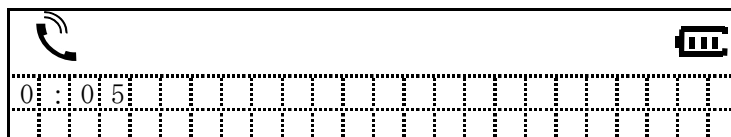

5. The LCD displays the following message to indicate the call time.



## 2.5 Redial (Option)

When the RF link is established between the Handset and the Base Station, the user can press the **REDIAL** key. The last number dialed is shown and the digits dialed are sent to the Base Station.

-  *Error tone is emitted when redial is empty.*
-  *Dial limit is 32 digits, redial stores up to 32 digits in memory.*
-  *Redial data is stored in Handset memory (EEPROM).*
-  *If **F1~F12** keys are pressed the number dialed before the Function key is pressed is stored in redial memory.*

### Example:

- (1) [talk][1][2][3][talk] redial: 123
- (2) [talk][1][2][3].....[1][2][talk] (over 32 digits) redial: 123.....12 (up to 32 digits)
- (3) [talk][1][2][3][F1][4][5][6][talk] redial: 123

## 2.6 AutoStandby<sup>®</sup>

When the Handset is in one of the modes listed below, placing the Handset on the Charger changes it to Standby Mode. At this time, a confirmation tone is emitted.

- Ringer volume setting
- Menu setting
- Talk Mode
- Trying to connect to the Base Station



## 2.7 PBX No Service

1. When the **TALK** or **Speaker** key is pressed, while the Base Station is using a wired phone, the LCD displays the following for five seconds with an error tone, and returns to Standby Mode.

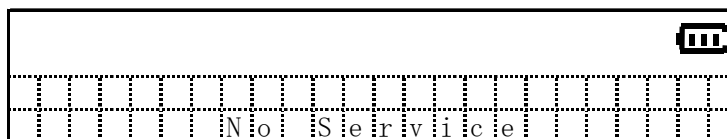

## 2.8 Out Of Range

### 2.8.1 When in Standby Mode

The Handset displays the message "Searching" when the Handset cannot find the Base Station (Out of Range) in Standby Mode.

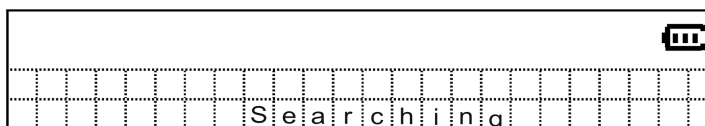

### 2.8.2 When Establishing an RF Link

If the **TALK**, **Speaker** or **F1~F4** key is pressed and the Handset cannot establish an RF Link with the Base Station, the Handset sounds an error tone and displays the message "Out of Range".

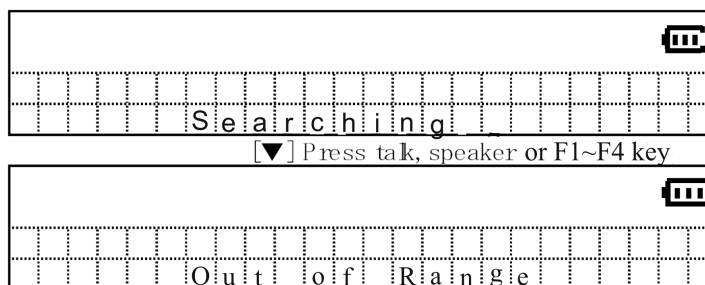

**2.8.3 While Talking**

If the Handset cannot receive a signal from the Base Station in about five seconds, it goes to Standby Mode and emits an error tone. In this case, the LCD displays the following message. If the base cannot receive a signal from the Handset in about five seconds, it goes to Standby Mode.

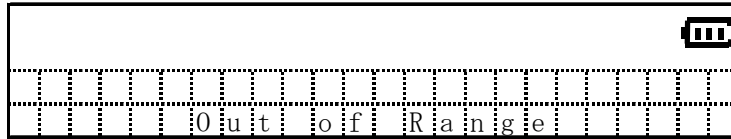

**2.9 Low Battery**

The Handset has visual and audible indicators to warn of a low-battery condition.

**2.9.1 In Standby Mode**

The Battery Status icon in the LCD changes to battery low. The "Charge Battery" message blinks on the LCD (ON: 600msec, OFF: 600msec).

**2.9.2 In Talk Mode**

The Battery Status icon in the LCD changes to battery low. The Handset remains in Talk Mode and the battery low alert tone is emitted every 30 seconds.

**2.9.3 In Other Mode (Excluding Standby Mode and Talk Mode)**

The Battery Status icon in the LCD changes to battery low.

**2.10 Battery Status**

The LCD indicates the battery capacity as indicated in the diagram below.

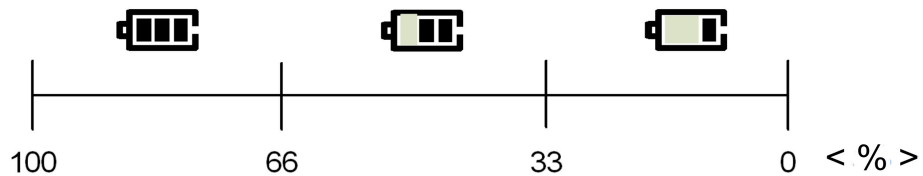

## 2.11 Handsfree

Press the **Speaker** key in Standby Mode or during Talk Mode. The Handset goes into Handsfree Talk Mode and the Handsfree icon is turned on.

Press **TALK** key in Handsfree Talk Mode. The Handsfree icon is turned off and goes into Talk Mode.

Press the **Speaker** key in Handsfree Talk Mode. The Handset disconnects the conversation and goes into Standby Mode.

## 2.12 Headset

To put the handset into Headset Mode:

Insert the Headset plug in Headset Jack in Talk Mode or Handsfree Talk Mode. The Handset goes into the Headset condition.

## 2.13 Volume Setting

The following modes have volume settings: Talk Mode, Handsfree Talk Mode and Headset.

During each mode, the user can press the **Volume Up** or **Volume Down** keys to increase or decrease the volume. As the user increases/decreases the volume setting, the setting is displayed on the LCD from Level 1 to Level 6. After the volume is changed, the LCD shows the current volume setting for five seconds.

 *The LCD shows the current volume for two seconds after changing the mode or condition.*

If messages are sent from a PBX, the LCD shows the message after the volume display.





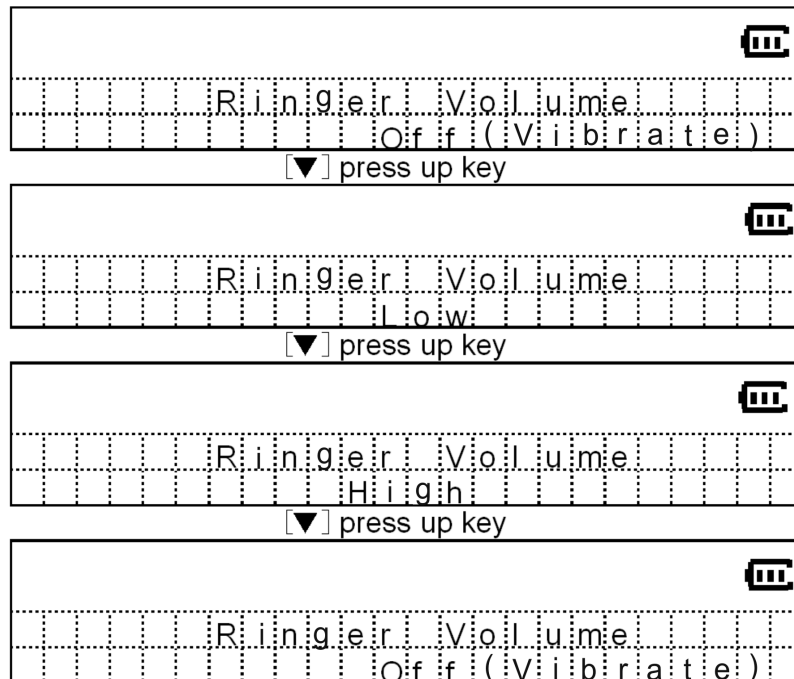

## 2.14 Ring Volume Setting

### 2.14.1 Ringer Tone/Volume Selection

When the **Volume Up** key is pressed in Standby Mode or Incoming Call Mode, the Handset goes into Ringer Volume Setting Mode and the current setting is displayed on the LCD.

The Ring volume changes as follows.



-  *The Handset keeps the Ringer Volume Setting Mode for two seconds without key operation.*
-  *When the Ringer Volume is Off (Vibrate), the Handset vibrates instead of ringing.*
-  *If Ringer Volume is off and the Handset is on the charger while in Incoming Call Mode, it rings Low, but does not vibrate.*
-  *If ringer mute is on, the Handset does not ring nor does it vibrate.*
-  *Press the **TALK** key or **Speaker** key in Ring Volume Setting Mode. The Handset cancels the ringer volume setting and goes into Standby Mode.*
-  *The handset can change ringer volume in Incoming Call Mode. In this case, the ringer volume does not appear on the display.*

## 2.15 Ringer Mute

If the **Volume Down** key is pressed and held for two seconds while in Standby Mode or Incoming Call Mode, the Handset sets the ringer mute on, turns on the Ringer Mute icon and stops the ringer.

To turn the Ringer Mute off, press and hold the **Volume Down** key for two seconds; ringer mute is turned off.

## 2.16 Menu Setting Mode

Press the **TALK** key or the **Speaker** key in each menu setting mode; the Handset goes into Standby Mode.

The Handset keeps each menu setting mode for one minute without key operation. The Handset Cancel Menu setting is activated and the handset goes into Standby Mode.

## 2.17 Changing Ringer Type

To change the ringer type:

1. Press the **MUTE(Menu)** key in Standby Mode; the LCD shows the menu list.

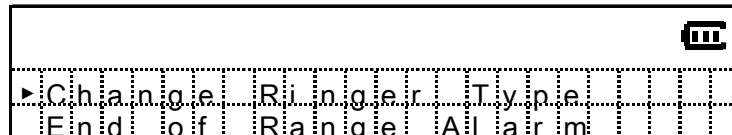

2. If needed, select "Change Ringer Type" by pressing the **Volume Up** or **Volume Down** key and pressing the **MUTE(Menu)** key. Otherwise, if the option is already selected, press only the **MUTE(Menu)** key.

- The LCD shows Tone Type. To select Tone A ~Tone F by pressing the **Up** or **Down** key.

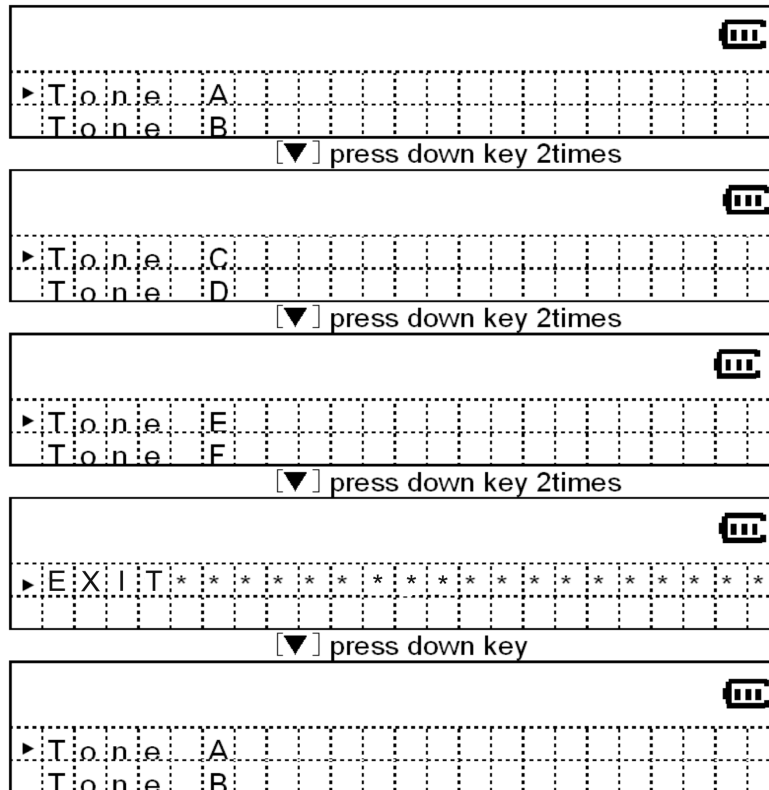

- Press the **MUTE(Menu)** key; the Handset outputs a confirmation tone and displays a message confirmation message on the LCD and goes into Menu List Mode.

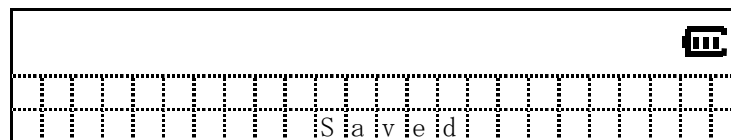

### 2.18 End of Range Alarm

- Press the **MUTE(Menu)** key while in Standby Mode. Then the LCD shows menu list.

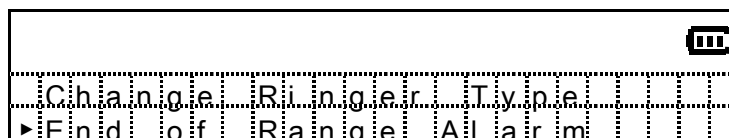

2. Select "End of Range Alarm" by pressing the **Volume Up** or **Volume Down** key and pressing the **MUTE(Menu)** key.
3. The LCD shows "On" and "Off". Select "On" or "Off" by pressing the **Volume Up** or **Volume Down** key and pressing the **MUTE(Menu)** key.

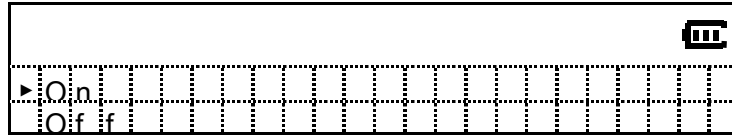

4. The Handset outputs a confirmation tone, displays the confirmation message on the LCD and goes into Menu List Mode.

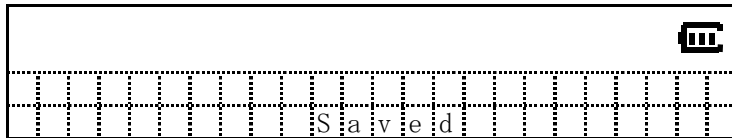

**THIS PAGE INTENTIONALLY LEFT BLANK**



# INDEX

## Numerics

16-hour talk time 1-1  
4-day standby time 1-1

## A

AC adapter 1-1, 2-2, 3-3, 5-1  
AutoStandby 2-3

## B

base unit 1-1, 2-2  
  controls 4-3  
  power requirements 1-1  
  receive frequency 1-1  
  size 1-1  
  transmit frequency 1-1  
  wall mounting 2-3  
  weight 1-1  
battery  
  910 mAh 5-1  
  charging 2-3, 3-3, 3-8, 3-13  
  charging unit 2-3  
  cleaning 3-16  
  handset 3-12  
  low indication 2-3, 3-15, 3-16  
  nickel-metal hydride 1-2  
  rechargeable 2-2  
  recycling 1-2  
  safety considerations 1-2  
  spare 2-3  
  spare battery 3-14  
belt clip 2-2, 5-1

## C

channel  
  automatic selection 2-3  
charger unit 2-7  
  buttons 2-6  
charging  
  handset battery pack 3-13  
  spare battery pack 3-14  
  stand 2-2, 2-3  
  unit 2-3, 3-3  
  wall mounting 3-8  
cleaning battery contacts 3-16  
conference key 2-5, 4-2

## D

data transmission speed 1-1  
direct wall mounting installation 3-6  
Dterm  
  Series E 2-3

## E

Electra Elite 2-3  
electrical considerations 1-4

## F

FCC 1-1, 1-5  
features

automatic channel selection 2-3  
AutoStandby 2-3  
charging stand 2-3  
charging unit 2-3  
handset  
  design 2-3  
  volume 2-3  
headset  
  volume 2-3  
headset jack 2-3  
low battery protection 2-3  
mute control 2-3  
single key access 2-3  
wall mountable base unit 2-3  
frequency  
  control 1-1  
  receive 1-1  
  transmit 1-1

## H

handset 1-1, 2-2  
  battery 1-1  
  battery pack 3-12, 3-13  
  design 2-3  
  power requirements 1-1  
  receive frequency 1-1  
  size 1-1  
  talk mode 1-1  
  transmit frequency 1-1  
  volume 2-3  
  weight 1-1  
headset 5-1  
  installing 5-2  
  jack 2-3  
  volume 2-3  
hold key 2-5, 4-2

## I

indications  
  batt low 3-16  
  battery low 3-15  
installation precautions 3-1  
installing  
  direct wall mounting 3-6  
  handset battery pack 3-12  
  headset 5-2  
  selecting location 3-1  
  standard wall plate 3-4

## K

keypad buttons  
  channel key 2-5  
  conference key 2-5, 4-2  
  hold key 2-5, 4-2  
  redial key 2-5  
  talk key 4-2  
  transfer key 2-5

## L

line problems 1-5  
low battery  
  protection 2-3

## M

- modes
  - programming 6-1
- modulation 1-1
- multiline telephone
  - using 6-1
- mute control 2-3

## N

- nickel-metal hydride battery 1-2
- Nickel-Metal Hydride battery pack 1-1

## O

- occupied bandwidth 1-1
- optional accessories
  - 910 mAh battery 5-1
  - AC adapter 5-1
  - Base 5-1
  - Base Stand 5-1
  - base unit
    - adapter 5-1
  - belt clip 5-1
  - charger 5-1
  - headset 5-1
  - telephone cords 5-1
  - Wall Mount 5-1
  - Wall Mount Adapter 5-1
- output power 1-1

## P

- phase lock loop 1-1
- power requirements 1-1
- privacy 1-4
- programming mode 6-1

## R

- r/vol key 4-3
- radio interference 1-5
- range 1-5
- recycling 1-2
- redial key 2-5

## S

- safety
  - battery 1-2
  - electrical 1-4
  - general instructions 1-3
- single access key 2-3
- site location 3-1
- spare battery pack 3-14
- specifications
  - base unit 1-1
  - frequency 1-1
  - frequency control 1-1
  - handset 1-1
  - modulation 1-1
  - phase lock loop 1-1
  - power requirements 1-1
  - spread spectrum 1-1
- standard wall plate installation 3-4
- standby mode 1-1, 4-2

## T

- talk
  - key 4-2
  - mode 1-1
- telephone
  - base unit 2-2
  - belt clip 2-2
  - charging stand 2-2
  - cord 2-2, 5-1
    - connecting 3-1
  - Dterm
    - Series E 2-3
  - Electra Elite 2-3
  - features 2-3
  - handset 2-2
  - headset 5-1
  - line problems 1-5
  - multiline telephone 6-1
  - privacy 1-4
  - radio interference 1-5
  - range 1-5
  - rechargeable battery 2-2
  - wall plate adapter 2-2
- temperature
  - specifications 1-1
- transfer key 2-5

## V

- volume
  - control
    - high 4-3
    - low 4-3
    - maximum 4-3
    - medium 4-3

## W

- wall mounting
  - base unit 2-3
  - charging unit 2-3, 3-8
  - direct 3-6
  - standard 3-4
- wall plate adapter 2-2



# NEC

***Dterm*<sup>®</sup> Cordless DECT**

**OWNER'S MANUAL**

**DTL-8R-1**